SPECTRUM + GX2355S
25 Watt VHF/FM
Marine Transceiver

Owner's Manual

- Submersible
- DSC distress call automatically broadcasts lat/long and vessel ID*
- MARITEL DSC telephone capability
- DSC position request function and NMEA data input/output
- Noise canceling Clear Voice Speaker microphone with channel selector
- 20 W Loud Hailer with Bells & Whistles
- Latitude/Longitude and SOG/COG display*
- Channel name capability
- Versatile user-programmable scanning and priority scan
- NOAA Weather Alert
- One-button access to Channel 16 and 9
- Access all US, Canadian and International channels
- Big, back-lit display and keys

*with GPS attached

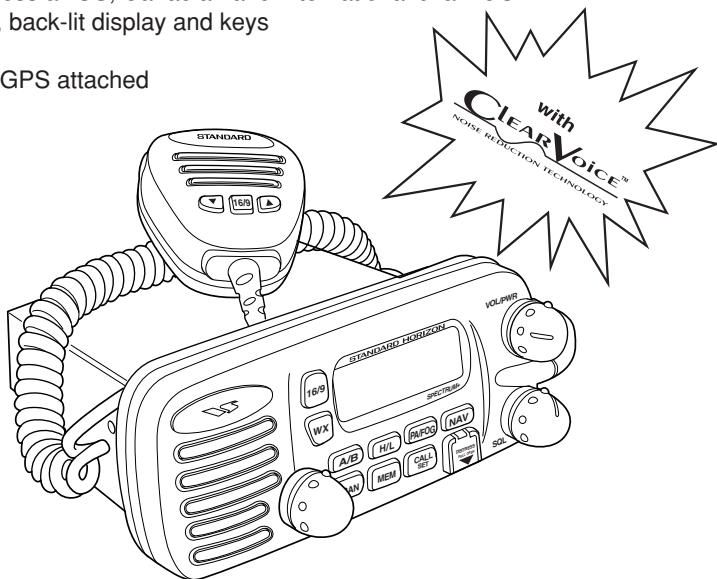

TABLE OF CONTENTS

FCC RADIO LICENSE INFORMATION	1	5.10 CHANNEL A /B INSTANT CALL	17
STATION LICENSE	1	5.10.1 Storing new channel A/B	17
RADIO CALL SIGN	1	5.10.2 Changing the stored channel A/B ..	17
CANADIAN SHIP STATION LICENSING ...	1	5.10.3 Operating the channel A/B	17
FCC NOTICE	2	5.11. PA/FOG OPERATION	17
1 GENERAL INFORMATION	3	5.11.1 Operating the PA HAIL mode	18
1.1 INTRODUCTION	3	5.11.2 Operating the FOG HORN mode	18
1.2 FCC/INDUSTRY CANADA INFORMATION ..	3	5.12 NAVIGATION INDICATION	19
2 ACCESSORIES	4	5.13 VOICE SCRAMBLER	19
2.1 PACKING LIST	4	5.13.1 Operation with voice scrambler ..	19
2.2 OPTIONS	4	5.14 RESETTING THE TRANSCEIVER'S	20
3 CONTROLS AND INDICATORS	5	MICROPROCESSOR	20
3.1 CONTROLS AND CONNECTIONS	5	6 DIGITAL SELECTIVE CALLING	21
4 INSTALLATION	10	6.1 GENERAL	21
4.1 LOCATION	10	6.1.1 Digital Selective Calling (DSC) ...	21
4.2 ELECTRICAL CONNECTIONS	10	6.1.2 Maritime Mobile Service Identity	21
4.3 ACCESSORY CABLE	11	(MMSI)	21
4.3.1 Cable pin number and signal	11	6.2 SENDING A DISTRESS CALL	22
4.4 CMB16 FLUSH MOUNT INSTALLATION ...	12	6.2.1 Sending a Distress Call	22
5 BASIC OPERATION	13	Automatically	22
5.1 RECEPTION	13	6.2.2 Sending a Distress Call and	23
5.2 TRANSMISSION	13	Manually Inputting a Position	23
5.3 TRANSMIT TIME - OUT TIMER (TOT) ...	14	6.3 SENDING A DISTRESS CALL WITH	24
5.4 SIMPLEX/DUPLEX CHANNEL USE ...	14	NATURE OF DISTRESS	24
5.5 USA, CANADA, AND INTERNATIONAL	14	6.4 SENDING AN INDIVIDUAL CALL	25
MODE	14	6.5 SENDING A GROUP CALL	26
5.6 NOAA WEATHER CHANNELS	15	6.6 SENDING AN ALL SHIPS CALL	27
5.7 NOAA WEATHER ALERT	15	6.7 MARITEL DSC TELEPHONE CALL	28
5.8 MEMORY SCANNING (M-SCAN)	16	6.7.1 Sending a Ship to Shore Call	28
5.9 PRIORITY SCANNING (P-SCAN)	16	6.7.2 Receiving a Shore to Ship Call ..	29
		6.7.3 Resend Telephone Call Signal ...	29
		6.7.4 Resend Telephone Call When	29
		Receive Busy Signal	29
		6.8 DSC STANDBY	30
		6.9 CALL WAITING DIRECTORY	30
		6.9.1 Operation of Distress Call Waiting .	31
		6.9.2 Operation of Individual Call Waiting ..	31
		6.10 POSITION REQUEST	32
		6.11 POSITION SEND	33

6.12 RECEIVING DSC CALLS	34	9.7 DIGITAL SELECTIVE CALLING (DSC) ..	55
6.12.1 Receiving a distress call	34	9.7.1 USCG DSC Watch	55
6.12.2 Receiving a distress relay call	35	9.8 MARITIME MOBILE SERVICE	
6.12.3 Receiving an all ships call	35	IDENTITY (MMSI)	55
6.12.4 Receiving a geographical area call ..	35	9.8.1 What is a MMSI?	55
6.12.5 Receiving an individual call	36	9.9 USING DIGITAL SELECTIVE CALLING	
6.12.6 Receiving a position request	36	FEATURES	55
7. DSC / RADIO SETUP MODE	37	9.9.1 Distress Call	55
7.1 SETUP	37	9.9.2 Individual Call	55
7.2 LAMP ADJUSTING	37	9.9.3 Group Call	56
7.3 LCD CONTRAST	37	9.9.4 Urgency Call	56
7.4 CH NAMING	38	9.9.5 Safety Call	56
7.5 INDIVIDUAL DIRECTORY SETUP (DSC) ..	39	9.9.6 Position request	56
7.6 DSC TELEPHONE DIRECTORY ID INPUT ...	40	9.9.7 Telephone Call	56
7.7 POSITION REQUEST REPLY TYPE ...	41	9.10 ADDITIONAL DIGITAL SELECTIVE	
7.8 VOICE SCRAMBLER	42	CALLING INFORMATION	56
7.9 KEY BEEP (ON OR OFF)	43	9.11 ABOUT VHF RADIO	56
7.10 INDIVIDUAL RING	43	9.12 SELECTING AN ANTENNA	57
7.11 TIME OFFSET	44	9.13 COAXIAL CABLE	57
7.12 USER MMSI INPUT	45	10 MAINTENANCE	58
7.13 GROUP MMSI INPUT	46	10.1 REPLACEMENT PARTS	58
7.14 DSC SCANNING	47	10.2 FACTORY SERVICE	59
TO CHANGE DSC SCAN METHOD:	47	10.3 TROUBLESHOOTING CHART	60
8 RAM MIC OPERATION	48	10.4 CONNECTION OF GPS WITH NMEA	
8.1 RAM MIC CONTROLS AND		OUTPUT	61
CONNECTIONS	48	11. CHANNEL ASSIGNMENTS	62
8.2 INDICATORS	50	12. WARRANTY	66
8.3 INTERCOM OPERATION	51	13 SPECIFICATIONS	69
8.3.1 Communication	51	13.1 GENERAL	69
8.3.2 Calling	51	13.2 TRANSMITTER	69
9 OPERATING PRACTICES	52	13.3 RECEIVER	69
9.1 EMERGENCY (CHANNEL 16 USE) ...	52	13.4 DSC	70
9.2 CALLING ANOTHER VESSEL			
(CHANNEL 16 OR 9)	52		
9.3 MAKING TELEPHONE CALLS	53		
9.4 OPERATING ON CHANNELS 13 AND 67 ...	54		
9.5 PROHIBITED COMMUNICATIONS ...	54		
9.6 NOAA WEATHER ALERT TESTING ...	54		

ON-LINE WARRANTY REGISTRATION

Please visit www.standardhorizon.com to register the SPECTRUM+ Marine VHF. It should be noted that visiting the Web site from time to time may be beneficial to you, as new products are released they will appear on the STANDARD HORIZON Web site.

PRODUCT SUPPORT INQUIRIES

If you have any questions or comments regarding the use of the SPECTRUM+, you can visit the STANDARD HORIZON Web site to send an E-Mail or contact the Product Support team at 562/404-2700 M-F 7:00-5:00PST.

FCC RADIO LICENSE INFORMATION

Standard Horizon radios comply with the Federal Communication Commission (FCC) requirements that regulate the Maritime Radio Service.

STATION LICENSE

An FCC ship station license is no longer required for any vessel traveling in U.S. waters which uses a VHF marine radio, RADAR or EPIRB, and which is not required to carry radio equipment. However, any vessel required to carry a marine radio on an international voyage, carrying a HF single side band radiotelephone or marine satellite terminal is required to carry a license. FCC license forms, including applications for ship (506) and land station licenses can be downloaded via the Internet at www.fcc.gov/forms. To obtain a form from the FCC, call (888) 225-5322.

RADIO CALL SIGN

Currently the FCC does not require recreational boaters to have a Ship Radio Station License. The USCG recommends the boats registration number and the state to be used.

CANADIAN SHIP STATION LICENSING

You may need a license when traveling in Canada. If you do need a license contact their nearest field office or regional office or write:

**Industry Canada
Radio Regulatory Branch
Attn: DOSP
300 Slater Street
Ottawa, Ontario
Canada, KIA 0C8**

FCC NOTICE

NOTICE

Unauthorized changes or modifications to this equipment may void compliance with FCC Rules. Any change or modification must be approved in writing by STANDARD HORIZON.

NOTICE

This equipment has been tested and found to comply with the limits for a Class B digital device, pursuant to Part 15 of the FCC Rules. These limits are designed to provide reasonable protection against harmful interference in a residential installation. This equipment generates, uses and can radiate radio frequency energy and, if not installed and used in accordance with the instructions, may cause harmful interference to radio communications. However, there is no guarantee that interference will not occur in a particular installation. If this equipment does cause harmful interference to radio or television reception, which can be determined by turning the equipment off and on, the user is encouraged to try to correct the interference by one or more of the following measures:

- Reorient or relocate the receiving antenna.
- Increase the separation between the equipment and receiver.
- Connect the equipment into an outlet on a circuit different from that to which the receiver is connected.
- Consult the dealer or an experienced radio/TV technician for help.

1.1 INTRODUCTION

The STANDARD HORIZON GX2355S is a VHF/FM transceiver designed for use in the frequency range of 156.025 to 163.275 MHz. The GX2355S requires 13.8V for operation and has a switchable RF output power of 1 watt or 25 watts.

The transceiver is capable of RTCM SC101 DSC (Digital Selective Calling) operation and intercom operation with the use of an optional RAM mic (CMP23 remote-control speaker/microphone with display).

The transceiver operates on all currently-allocated marine channels which are switchable for use with either USA, International, or Canadian regulations. It has an emergency channel 16 which can be immediately selected from any channel by pressing the red **16/9** key. NOAA Weather channels can also be accessed immediately by pressing the **WX** key with channel selection.

Other features of the transceiver include: scanning, priority scanning, public address (PA) mode, submersible noise-canceling speaker mic, high and low voltage warning, and GPS repeatability.

1.2 FCC/ INDUSTRY CANADA INFORMATION

The following data pertaining to the transceiver is necessary to fill out the license application.

Type Acceptance	FCC Part 80
Output Power	1 Watt (low) and 25 Watts (high)
Emission	16K0F3E, 16K0G3E
Frequency Range	156.025 to 163.275 MHz
FCC Type Number	K66GX2350S
Industry Canada Type Approval	511822205AV

2.1 PACKING LIST

When the package containing the transceiver is first opened, please check it for the following contents:

- GX2355S SPECTRUM + Transceiver (White/Black)
- CMP351W/CMP351B (White/Black Microphone attached to the transceiver) and hanger kit
- Mounting Bracket and attaching hardware
- Spare Fuse (6 A, 250 V)
- Owner's Manual
- Quick-Reference Card
- Accessory Cable
- Power Cord
- Dust Cover

2.2 OPTIONS

CMB16	Flush-Mount Bracket
CMP23	Remote-Access Microphone (RAM Mic, Black / White)
CAW23	10-foot Extension Cable for RAM Mic
CVS2500	Voice Scrambler
101S	Mini Extension Speaker
201S	White Extension Speaker
201SZ	White Flush Mount Extension Speaker
201SBK	Black Extension Speaker
201SBKZ	Black Flush Mount Extension Speaker
220SW	4.5" Round Hailer / PA Horn
240SW	5" X 8" Rectangular Hailer / PA Horn

NOTE

This section defines each control of the transceiver. See Figure 1 for location of controls. For detailed operating instructions refer to chapter 4 of this manual.

3.1 CONTROLS AND CONNECTIONS

① POWER SWITCH/VOLUME CONTROL

Turns the transceiver on and off as well as adjusts the audio volume. To turn the transceiver on press and hold this knob until the LCD turns on. To turn it off, press and hold this knob until the LCD turns off. When the power is turned on, the transceiver is set to the last selected channel.

Secondary Use

When the transceiver is turned on while the **SCAN** and **WX** keys are held down, the internal microprocessor is reset. This clears the memory and all user-programmed settings, such as scan memory, priority scan assignments, and A/B channel assignments. This condition is known as the default condition, the same as when shipped from the factory. For a list of these defaults, see the section on Resetting the Transceiver's Microprocessor.

NOTE

Resetting the microprocessor **will not erase** DSC MMSI and Directory Call Waiting information.

② SQUELCH CONTROL (SQL)

Sets the point at which random noise on the channel does not activate the audio circuits but a received signal does. This point is called the squelch threshold. Further adjustment of the squelch control will degrade reception of wanted transmissions.

③ KEY PAD

16/9 Key

Immediately recalls channel 16 from any channel location. Holding down this key recalls channel 9. Pressing the **16/9** key again reverts to the previous selected working channel.

Secondary use

Please see secondary use for the **WX** and **MEM** key.

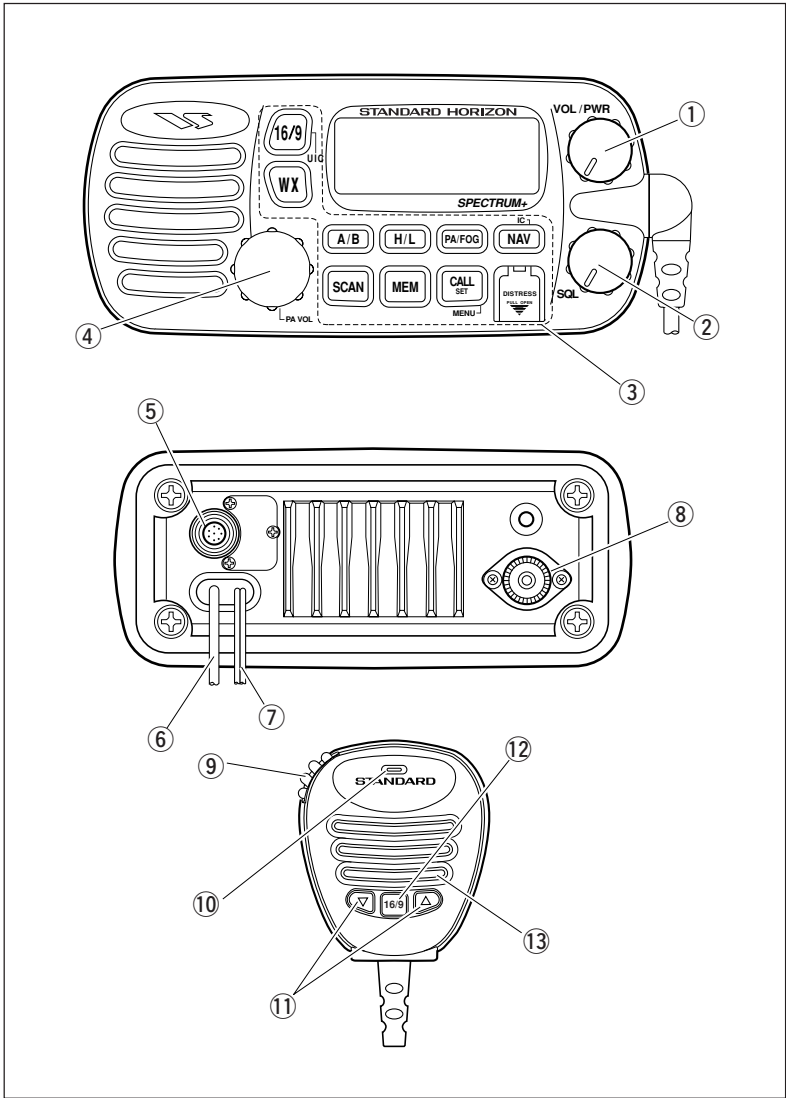

Figure 1. Controls and Connectors

WX Key

Immediately recalls the previously selected NOAA weather channel from any channel location.

Secondary use

1. Holding down the **16/9** key while pressing the **WX** key changes the mode from USA to International or Canadian.

NOTE

If position is displayed, this icon will be hidden.

2. Holding down the **WX** and **SCAN** key while turning the power on resets the microprocessor and erases scan channels from memory. This clears the memory and establishes the factory-set defaults. For a list of these defaults, see the section on Resetting the Transceiver's Microprocessor.

SCAN Key

1. Starts and stops scanning of programmed channels.
2. If held while the **UP** or **DOWN** keys on the mic case are pressed or **Channel Selector** knob on radio is turned, the radio will show the channels in scan memory. This function will not work if the unit is scanning.

NOTE

There is only one priority channel. However, it can be assigned to a channel other than WX and CH70. The priority channel is marked with P-CH on the LCD.

MEM Key

Memorizes the selected channel into the transceivers scan memory for scanning. When pressed again, it DELETES the channel from the scan memory.

Secondary use

The MEM key is also used to select a priority channel.

1. Select the desired channel.
2. Press and hold the MEM key until the display shows P-CH.

NOTE

If position is displayed, this icon will be hidden.

DISTRESS Key

To send the distress call see section 6.2, (Sending a Distress Call).

PA/FOG key

Available to operate the PA function or the FOG HORN function

A/B Key

Immediately recalls two user assigned channels from any channel.

CALL/SET Key

The **CALL/SET** key functions as the enter key.

Secondary use

Press the **CALL/SET** key to access the DSC OPERATION menu. The following DSC functions can be accessed from the DSC OPERATION menu; INDIVIDUAL, GROUP, ALL SHIPS, TELEPHONE, STANDBY, CALL WAIT, POS REQUEST and POS SEND.

Press and hold the **CALL/SET** key to access the SETUP menu. The following functions can be accessed in the SETUP menu; LAMP ADJUST, CONTRAST, CH NAME, INDIV DIR, TELEPHONE MEMORY ID, POS REPLY, SCRAMBLER, KEY BEEP, INDIV RING, TIME SET, USER MMSI, GROUP MMSI, DSC SCAN.

H/L Key

Toggles between high and low power. When the **H/L** key is pressed while the transceiver is on channel 13 or 67, the power will temporarily switch from LO to HI power until the **PTT** is released. The **H/L** key does not function on transmit inhibited and low power only channels.

NAV / IC Key

1. Pressing this key, when connected to the GPS receiver, the LCD displays position data, Date, Time, SOG (Speed Over Ground) and COG (Course Over Ground) from the GPS.
2. Press and hold down this key, when the optional RAM Mic is connected. Intercom operation will operate between radio and RAM Mic.

④ CHANNEL SELECTOR KNOB

Rotary knob used to select channels and, to choose the item selection of different functions (DSC operation, PA/FOG operation and etc.). The CH key on the microphone can also be used to select them.

Secondary Use

While holding down the **SCAN** Key and turning the **Channel Selector** knob, you can confirm memory channels for scanning.

⑤ RAM MIC CONNECTOR

Connects the Remote Access Microphone (RAM MIC). Refer to "section 8.0, (RAM MIC OPERATION).

⑥ ACCESSORY CONNECTION CABLE

Connects the radio to a GPS, external PA horn, and an external speaker.

⑦ DC INPUT CABLE

Connects the radio to a DC power supply of 13.8V

⑧ ANTENNA JACK

Connects an antenna to the transceiver. Use a marine VHF antenna with an impedance of 50 ohms.

⑨ PTT (Push-To-Talk) SWITCH

Keys the transmitter when the transceiver is in radio mode. If the transceiver is in the intercom operation mode, it activates the microphone for the intercom.

⑩ CLEAR VOICE NOISE-CANCELING SPEAKER MIC

Transmits the voice message with reduction of background noise.

⑪ UP ▲ and DOWN ▼ KEYS

The **UP ▲** and **DOWN ▼** on the mic function the same as the **Channel Selector** knob on the front panel of the transceiver.

⑫ 16/9 Key

Pressing the **16/9** key immediately recalls channel 16 from any location. Press and hold the **16/9** key to recall channel 9. Pressing the **16/9** key again reverts the radio to the previous select channel.

⑬ MICROPHONE SPEAKER

The same audio heard through internal radio speaker as heard through microphone speaker.

4.1 LOCATION

1. The radio can be mounted at any angle. Choose a mounting location that:
 - is far enough from any compass to avoid any deviation in compass reading due to the speaker magnet
 - provides accessibility to the front panel controls
 - allows connection to a power source and an antenna
 - has nearby space for installation of a microphone hanger
 - the antenna must be mounted at least 3 feet from radio

4.2 ELECTRICAL CONNECTIONS

CAUTION

Reverse polarity connections will damage the radio!

Connect the power cord and antenna to the radio. Antenna and Power Supply connections are as follows (see Figure 2):

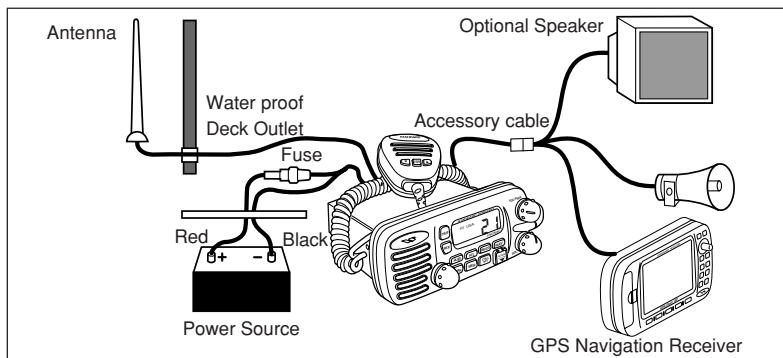

Figure 2. General Installation

1. Mount the antenna at least 3 feet away from the radio. At the rear of the radio, connect the antenna cable. It must have a PL259 connector. RG-8/U coaxial cable must be used if the antenna is 25 feet or more from the radio. RG58 cable can be used for distances less than 25 feet.

2. Connect the red power wire to a 13.8 VDC \pm 20% power source. Connect the black power wire to a negative ground.
3. If an optional remote extension speaker is to be used, refer to section 4.3 for connections.
4. It is advisable to have a Certified Marine Technician check the power output and the standing wave ratio of the antenna after installation.

4.3 ACCESSORY CABLE

4.3.1 Cable pin number and signal

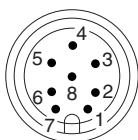

Pin number	Signal
1	External speaker (+)
2	External speaker (-)
3	PA (+)
4	NMEA IN (+)
5	PA (-)
6	NMEA IN (-)
7	NMEA OUT (-)
8	NMEA OUT (+)

NMEA 0183 Version (1.5 to 2.3) Input Sentences:

GLL – Geographic Position–Longitude/Latitude

RMC – Recommended Minimum Specific GNSS Data

NMEA 0183 Version (2.3) Output Sentences:

DSC – Digital Selective Calling Information

DSE – Expanded Digital Selective Calling Information

When connecting the external speaker or GPS navigation receiver, strip off about 1 inch (2 cm) of the specified wire's insulation.

NOTE

Never short wires. This may lead to malfunctions.

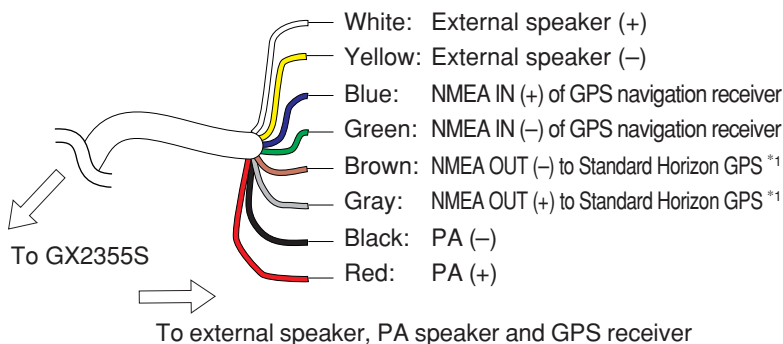

*1: Connecting these wires to Standard Horizon GPS to show a DSC Position Request, Position Send or Distress Call on the display of the GPS.

4.4 CMB16 FLUSH MOUNT INSTALLATION

1. Make a rectangular template for the flush mount measuring 2-1/8" H x 5-3/4" W.
2. Use the template to mark the location where the rectangular hole is to be cut. Confirm the space behind the dash or panel is deep enough to accommodate the transceiver (at least 6 inches deep). There should be at least 1/2 inch between the transceiver's heatsink and any wiring, cables or structures.
3. Cut out the rectangular hole and insert the transceiver.
4. Fasten the brackets to the sides of the transceiver with the lock washer nut combination, so that the mounting screw base faces the mounting surface (see Figure 3).
5. Turn the adjusting screw to adjust the tension so that the transceiver is tight against the mounting surface.

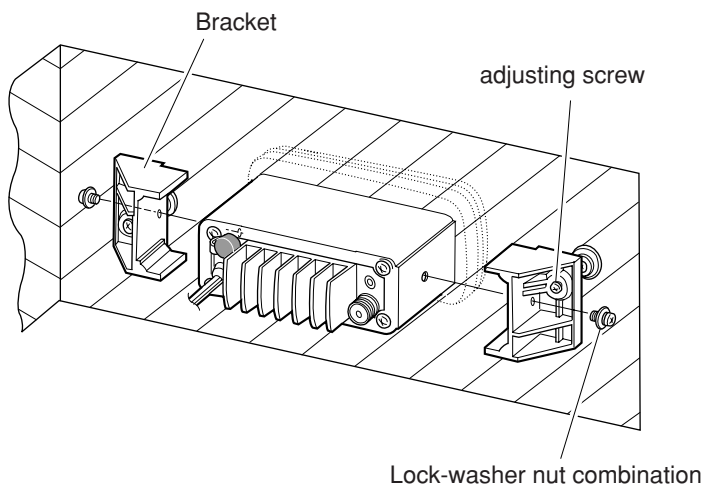

Figure 3. CMB16 Flush Mount Installation

5.1 RECEPTION

1. After the transceiver has been installed, ensure that the power supply and antenna are properly connected.
2. Press and hold the **VOL/PWR** knob until the radio turns on.
3. Turn the **SQL** knob fully counterclockwise. This state is known as “squelch off”.
4. Turn up the volume until noise or audio from the speaker is at a comfortable level.
5. Turn the **SQL** knob clockwise until the random noise disappears. This state is known as the “squelch threshold.”
6. Press the **UP** or **DOWN** key to select the desired channel. Refer to the channel chart (section 11 CHANNEL ASSIGNMENTS) for available channels.
7. When a message is received, adjust the volume to the desired listening level. The “BUSY” indicator in the LCD is displayed indicating that the channel is being used.

5.2 TRANSMISSION

1. Perform steps 1 through 6 of RECEPTION.
2. Before transmitting, monitor the channel to ensure it is clear. **THIS IS AN FCC REQUIREMENT!**
3. Press the **PTT** (push-to-talk) switch. The TX indicator on the LCD is displayed.
4. Speak slowly and clearly into the microphone.
5. When the transmission is finished, release the **PTT** switch.

NOTE

This is a noise-canceling microphone. The oval slot on the top front of microphone should be positioned within 1 inch (2 cm) from the mouth for optimum performance.

6. Refer to the section 9 OPERATING PRACTICES for standard transceiver operating procedures.

5.3 TRANSMIT TIME - OUT TIMER (TOT)

When the **PTT** switch on the microphone is held down, transmit time is limited to 5 minutes. This prevents unintentional transmissions. About 10 seconds before automatic transmitter shutdown, a warning beep will be heard from the speaker(s). The transceiver will automatically go to receive mode, even if the **PTT** switch is continually held down. Before transmitting again, the **PTT** switch must first be released and then pressed again.

5.4 SIMPLEX/DUPLEX CHANNEL USE

Refer to the channel chart (section 11 CHANNEL ASSIGNMENTS) for instructions on use of simplex and duplex channels.

NOTE

All channels are factory-programmed in accordance with FCC (USA), Industry Canada (Canada), and International regulations. Mode of operation cannot be altered from simplex to duplex or vice-versa.

5.5 USA, CANADA, AND INTERNATIONAL MODE

1. To change the modes, hold the **16/9** key and press the **WX** key. The mode changes from USA to International to Canadian with each press of the **WX** key.
2. USA will be displayed on the LCD for USA mode, INTL will be displayed for International mode, and CAN will be displayed for Canadian mode.
3. Refer to the channel chart (section 11 CHANNEL ASSIGNMENTS) for allocated channels in each mode.

5.6 NOAA WEATHER CHANNELS

1. To receive a NOAA weather channel, press the **WX** key from any channel. The transceiver will go to the last selected weather channel.
2. Turn the **Channel Selector** knob on the radio or on the microphone to select a different NOAA weather channel.
3. To exit from the NOAA weather channels, press the **WX** key. The transceiver returns to the channel it was on prior to a weather channel.

5.7 NOAA WEATHER ALERT

In the event of extreme weather disturbances, such as storms and hurricanes, the NOAA (National Oceanic and Atmospheric Administration) sends a weather alert accompanied by a 1050 Hz tone and subsequent weather report on one of the NOAA weather channels. The transceiver is capable of receiving this alert if the following is performed:

1. Program NOAA weather channels into the transceiver's memory for scanning. Follow the same procedure as for regular channels under Section 5.8.
2. Press the **SCAN** key once to start memory scanning or hold down the **SCAN** key during memory scanning to start priority scanning.
3. The programmed NOAA weather channels will be scanned along with the regular-programmed channels. However, scanning will not stop on a normal weather broadcast unless a NOAA alert is received.
4. When an alert is received on a NOAA weather channel, scanning will stop and the transceiver will emit a loud beep to alert the user of a NOAA broadcast.
5. Press the **WX** key to stop the alert tone and receive the weather report.

NOTE

If the **WX** key is not pressed the alert tone will be emitted for 5 minutes and then the weather report will be received.

5.8 MEMORY SCANNING (M-SCAN)

NOTE

- During scanning, the dot matrix area of the LCD will show M-SCAN or P-SCAN depending on the scan mode selected.
- The channel numbers programmed will cycle on the LCD.
- If position is displayed this icon will be hidden.

1. Adjust the **SQL** knob until background noise disappears.
2. Select a desired channel to be scanned using the **Channel Selector** knob. Press the **MEM** key, MEM will appear on the LCD which indicates the channel has been programmed into the transceivers memory.
3. Repeat step 2 for all the desired channels to be scanned.
4. To DELETE a channel from the transceiver's memory, press the **MEM** key, MEM will disappear in the LCD.
5. To start scanning, press the **SCAN** key. Scanning will proceed from the lowest to the highest programmed channel number and will stop on a channel when a transmission is received.
6. The channel number will blink during reception.



7. To stop scanning, press the **SCAN**, **16/9**, **WX**, or **PTT** key.

5.9 PRIORITY SCANNING (P-SCAN)

1. Any channel can be set as the priority channel, other than weather channels and channel 70. To set the priority channel, select the desired channel. Press and hold down the **MEM** key until P-CH is shown on the display.



2. To select priority scanning, hold down the **SCAN** key until P-SCAN appears on the LCD during memory scanning. Scanning will proceed between the memorized channels and the priority channel. The priority channel will be scanned after each programmed channel.

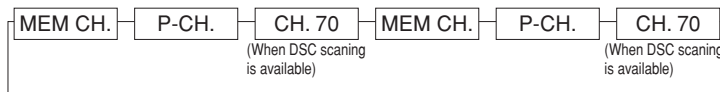



3. The scanning will be performed while receiving the MEM CH (memorized channel).

4. To stop scanning, press the **SCAN**, **16/9**, **WX**, or **PTT** key.

NOTE

Triple watch (T/W) means the radio is watching CH70 for DSC Calls.
Dual watch (D/W) means the radio is not watching CH70 for DSC Calls.

5.10 CHANNEL A /B INSTANT CALL

Two calling channels (used by an organization or a favorite channel) can be preset. But USA channels 9 and 16, and WX channels should not be assigned as A or B channels because they are readily available with the **16/9** and **WX** keys. If the **A/B** key is pressed and no channel A or B has been assigned, the alert signal will be present.

5.10.1 Storing new channel A/B

1. Press and hold down the **A/B** key and rotate the **Channel Selector** knob to select the desired channel.
2. Release the **A/B** key to store a desired channel as channel A/B.
3. Repeat steps to program second channel A/B.

5.10.2 Changing the stored channel A/B

1. Press the **A/B** key for memorized channel to appear.
2. Press and hold down the **A/B** key and rotate the **Channel Selector** knob to select the desired channel.
3. Release the **A/B** key to store a desired channel as channel A/B.

NOTE

The stored channels will delete in microprocessor resetting mode only.

5.10.3 Operating the channel A/B

Pressing the **A/B** key more than once toggles between channel A, channel B and the channel that was received on.

5.11. PA/FOG OPERATION

PA HAIL mode:

PA HAIL mode allows the transceiver to be used as a power hailer when an optional 4 ohm hailer speaker is installed. The Hail mode has a listen-back feature which provides two way communication through the hailer speaker.

FOG HORN mode:

Automatic signaling is transmitted through the PA speaker.

5.11.1 Operating the PA HAIL mode



1. Press the **PA/FOG** key.
Toggle between the PA HAIL and FOG HORN mode by pressing the **PA/FOG** key.
2. Press the PTT switch to speak through the hail speaker.
Rotate the **Channel Selector** knob to control the AF output level. The AF output level can be set from 0 to 20 watts.
3. To exit the PA HAIL mode, press the **16/9, WX** or **CALL SET** key.

5.11.2 Operating the FOG HORN mode

Operator can select from FOG 1, FOG 2, FOG 3, FOG 4, HORN, SIREN, AGROUND, or ANCHOR.

FOG 1: POWER BOAT UNDERWAY

FOG 2: POWER BOAT STOPPED

FOG 3: SAIL BOAT, FISH VESSEL, TOW VESSEL

FOG 4: VESSEL UNDER TOW



1. Press the **PA/FOG** key on PA HAIL mode.
Toggle between the PA HAIL and FOG HORN modes by pressing the **PA/FOG** key.
2. Turn the **Channel Selector** knob to select the function.
3. Press the **CALL/SET** key to operate the FOG HORN mode.
Horn – When PTT is pressed, emits HORN SOUND from the PA speaker.
Siren – When PTT is pressed, emits SIREN SOUND from the PA speaker.



4. On the SIREN and FOG HORN modes, press the **PTT** switch to activate the tone through the PA speaker.
Turn the **Channel Selector** knob to control the AF output level. The AF output level can be set from 0 to 20 watts.
5. To exit the FOG HORN mode, press the **16/9, WX** or **CALL SET** key.

5.12 NAVIGATION INDICATION

The transceiver has the ability to display the time, SOG and COG date, as well as the vessel's position (LAT/LON), if connected to a GPS receiver.

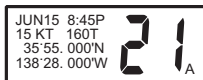

1. Press the **NAV** key to display position information.

If the GPS receiver receives no signal, the display will be as shown in the illustration on the left.

2. To hide the position information, press the **NAV** key.

NOTE

- The TIME OFFSET should be set to local time in the DSC/RADIO setup mode when the radio is connected to the GPS navigation receiver. To adjust TIME OFFSET to your local time, refer to section 7.11 TIME OFFSET.

5.13 VOICE SCRAMBLER

If privacy of communications is desired, a CVS2500 voice scrambler (VS) can be installed in the transceiver. Contact your Dealer to have a CVS2500 installed. Refer to the section 7.8 of DSC/RADIO SET UP mode to program the voice scrambler.

5.13.1 Operation with voice scrambler

1. Turn on the transceiver.

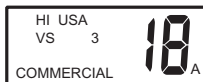

2. Select a channel that was programmed for scrambler mode. (Example: the voice scrambler code is set 3.)

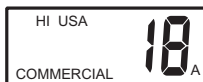

If a channel is not set for the voice scrambler, the display will be as shown in the illustration on the left.

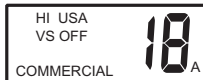

If a voice scrambler is canceled temporarily in the SETUP menu, the display will be as shown in the illustration on the left.

3. Monitor the channel before transmitting.
4. Transmit the voice message. The signal sent will be scrambled.

5.14 RESETTING THE TRANSCEIVER'S MICROPROCESSOR

Resetting the microprocessor restores the initial, factory supplied conditions in the transceiver. These are called the default conditions.

To reset the microprocessor, first turn the transceiver off. Then while pressing the **WX** and **SCAN** keys, turn the transceiver on. The default conditions are:

- No channels in the SCAN memory.
- Channel 16 will be selected when the transceiver is turned on.
- WX channel 01 will be recalled when the **WX** key is pressed.
- Key beep will be on.
- No channels will be stored in the A/B memory.

NOTE

Resetting the microprocessor will not erase DSC MMSI and Directory Call Waiting information.

6.1 GENERAL

6.1.1 Digital Selective Calling (DSC)

Digital Selective Calling is a semi-automated method of establishing a radio call, it has been designated by the International Maritime Organization (IMO) as an international standard for establishing VHF, MF and HF radio calls. It had also been designated part of the Global Maritime Distress and Safety System (GMDSS). It is planned that DSC will eventually replace aural watches on distress frequencies and will be used to announce routine and urgent maritime safety information broadcasts.

This new service will allow mariners to instantly send a distress call with GPS position (when connected to the transceiver) to the USA Coast Guard and other vessels within range of the transmission. DSC will also allow mariners to initiate or receive distress, urgency, safety and routine calls to or from another vessels equipped with a DSC transceiver.

6.1.2 Maritime Mobile Service Identity (MMSI)

What is an MMSI?

An MMSI is a nine digit number used on Marine Transceiver capable of using Digital Selective Calling (DSC). This number is used like a telephone number to selectively call other vessels. Refer to section 7.7 (USER MMSI INPUT).

How can I obtain a MMSI assignment?

Contact your dealer or Standard Horizon for details.

WARNING

This radio is designed to generate a digital maritime distress and safety call to facilitate search and rescue. To be effective as a safety device, this equipment must be used only within communication range of a shore-based VHF marine channel 70 distress and safety watch system. The range of signal may vary but under normal conditions should be approximately 20 nautical miles.

6.2 SENDING A DISTRESS CALL

The distress call automatically includes the vessel's DSC MMSI and Lat/Lon position. Refer to section 7.12, USER MMSI INPUT. The vessel's position can be sent only if the transceiver is properly connected to an operating GPS receiver.

6.2.1 Sending a Distress Call Automatically



1. Lift the red spring loaded **DISTRESS** cover and press the **DISTRESS** key. The distress menu will appear on the LCD.

NOTE

If GPS is connected skip steps 2 and 3 and go directly to step 4.

(When No GPS is connected or INVALID is displayed, LCD shows below figure.)



2. Press the **DISTRESS** or **CALL/SET** key until the distress sending menu appear. When a GPS is connected and INVALID is not displayed, LCD will show step 4.

3. Turn the **Channel Selector** knob to select **SEND**.

When you select **MANUAL**, refer to 6.2.2 Sending a Distress Call Manually.



4. Press and hold the **DISTRESS** or **CALL/SET** key for 3 seconds or more. Holding time will appear on the LCD.



5. When the distress signal is sent, the dot-matrix area of the LCD will be as shown in the illustration on the left.

After the message has been sent, the Distress Alarm will sound.

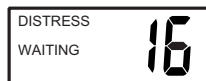

6. The transceiver “shadow-watches” for a transmission between CH16 and CH70 until an acknowledgment signal is received. “**DISTRESS**” and “**WAITING**” will appear on the LCD.

7. If no acknowledgment is received, the distress call is repeated in 4 minute intervals until an acknowledgment is received.

(When DISTRESS signal has been sent and it will be sent again, LCD shows below figure.)

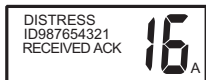

8. To cancel a Distress Call, press the **16/9** key, turn the **Channel Selector** knob to select **CANCEL**. Then, press the **CALL/SET** key or turn off the radio.

9. When a distress acknowledgment is received, a distress alarm sounds and channel 16 is automatically selected.

LCD shows ID and the answering type.

RECEIVED ACK: acknowledgment signal is received.

RECEIVED RLY: relay signal is received from other vessel or coast station.

10. To cancel the alarm, press any key.

NOTE

When a GPS receiver with NMEA output is connected, the vessel's position is automatically transmitted with the distress call.

6.2.2 Sending a Distress Call and Manually Inputting a Position

1. Perform steps 1 through 2 of 6.2.1 Sending a Distress Call Automatically.



2. Turn the **Channel Selector** knob to select **MANUAL** and press the **CALL/SET** key.



3. Turn the **Channel Selector** knob to select the desired numeral and press the **CALL/SET** key. UTC (Universal Time Coordinates also known as GMT) area is entered for a time. The time can be entered through 0:00 - 23:59. “- ’ --’ N” area is entered the north latitude. The north latitude can be entered through 0’00 - 90’00. “- ’ --’ W” area is entered the west longitude. The west longitude can be entered through 0’00’ - 180’00.

4. Press and hold the **DISTRESS** key for 3 seconds or more. Holding time will appear on the LCD.

5. Perform steps 5 through 10 of 6.2.1 Sending a Distress Call Automatically.

6.3 SENDING A DISTRESS CALL WITH NATURE OF DISTRESS

The NATURE OF on type of distress call can be selected and transmitted. The distress call automatically includes the vessels DSC MMSI and Lat/Lon position. The vessels position will be sent only if the transceiver is properly connected to an operating GPS receiver.



1. Lift the red spring loaded DISTRESS cover and press the red **DISTRESS** key. The distress call menu will appear.



2. Turn the **Channel Selector** knob or press the **UP** or **DOWN** key on the microphone to select the nature of distress (NATURE OF).



3. Press the **CALL/SET** key. The dot-matrix area of LCD will be as shown in the illustration on the left.

4. Turn the **Channel Selector** knob or press the **UP** or **DOWN** key on microphone to select the NATURE OF DISTRESS. To send a DISTRESS CALL with NATURE OF DISTRESS, press and hold **CALL/SET** key until the distress signal is sent.



5. After a message has been sent, the transceiver "DSC SCAN" between CH16 and CH70 until an acknowledgment is received. (Example: Fire is sent.)
6. If no acknowledgment is received, the distress call is repeated in 4 minute intervals until an acknowledgment is received. To cancel this, turn power OFF then ON again.
7. When a distress acknowledgment is received, emergency alarm sounds and channel 16 is automatically selected.
8. To cancel the alarm, press any key.

6.4 SENDING AN INDIVIDUAL CALL

This feature allows the user to contact another user vessel DSC and to automatically switch the receiving DSC radio to a desired working channel. This feature is similar to calling a vessel on CH16 and requesting to go to another channel. To send an individual call, see section 7.5 INDIVIDUAL DIRECTORY SETUP. The individual call function allows you to transmit a DSC signal to a specific party only, prompting communication on a voice channel.



1. Select the traffic channel for voice communication.

2. Press the **CALL/SET** key.
The DSC CALLING menu will appear.



3. Turn the **Channel Selector** knob to select INDIVIDUAL.
(To cancel, select EXIT with the **Channel Selector** knob or press the **16/9** key.)



4. Press the **CALL/SET** key.
The transceiver will beep, and the individual directory will appear.



5. Turn the **Channel Selector** knob to select the individual you want to contact.

6. Press the **CALL/SET** key to transmit the individual DSC signal.

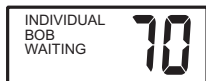

7. After INDIVIDUAL CALL is transmitted, the transceiver will wait 8 seconds for the acknowledgment. If the reply signal is not received, the transceiver will transmit again.



8. After the second INDIVIDUAL CALL is transmitted, if the reply signal is not received, the dot matrix area of the LCD will display ">SEND" to prompt the user to send the call again or exit the mode.



9. When an individual call acknowledgment "able to comply" is received, the established channel is automatically selected and an alarm sounds.



10. When an individual call acknowledgment with “unable to comply” is received, the established channel is automatically selected.

11. To cancel, select EXIT using the **Channel Selector** knob and press the **CALL/SET** key.

This procedure can be also canceled as follows;

Press the **CALL/SET** key or **16/9** key.

6.5 SENDING A GROUP CALL

This feature allows the user to contact a group of specific vessels using DSC and to automatically switch to a desired channel. This feature allows you to transmit a DSC signal with group MMSI that has been set according to section 7.13 Group MMSI INPUT.



1. Select the desired channel to use Group Call for voice communications.



2. Press the **CALL/SET** key. The DSC CALLING menu will appear.



3. Turn the **Channel Selector** knob to select GROUP. To cancel, select EXIT with the **Channel Selector** knob or press **16/9** key.

4. Press the **CALL/SET** key.



5. Turn the **Channel Selector** knob to select SEND. To cancel, select EXIT with the **Channel Selector** knob or press **16/9** key.



6. Press the **CALL/SET** key. When the Group Call signal is sent, the dot-matrix area of the LCD will be as shown in the illustration on the left.



7. After the GROUP CALL is transmitted, all the radios in the group will switch to the designated channel.

6.6 SENDING AN ALL SHIPS CALL

The All Ships Call function allows contact to be established with other vessel stations without having their ID in the individual calling directory. Also, priority for the call can be designated as Urgency, Safety or Routine. **URGENCY Call:** This type of call is used when a vessel may not truly be in distress, but have a potential problem that may lead to a distress situation. **SAFETY Call:** Used to transmit boating safety information to other vessels. This message usually contains information about an overdue boat, debris in the water. Loss of a navigation aid or an important meteorological message.



1. Select the traffic channel (for voice communication).



2. Press the **CALL/SET** key. The DSC CALLING menu will appear.



3. Turn the **Channel Selector** knob to select ALL SHIPS.



4. Press the **CALL/SET** key.
To cancel this, turn the **Channel Selector** knob to select EXIT.



5. Turn the **Channel Selector** knob to select the nature of call (URGENCY, SAFETY or ROUTINE).



6. Press the **CALL/SET** key to transmit the selected type of ALL SHIPS DSC call. When ROUTINE is selected, the signal is transmitted then the transceiver will wait on the channel selected in step 1.



7. After the ALL SHIPS CALL is transmitted, the transceiver will wait on CH16 except ROUTINE.

6.7 MariTEL DSC TELEPHONE CALL

DSC telephone function allows the user to transmit and receive DSC telephone calls automatically from ship to a shore based telephone (MariTel) coast station, or from a shore based telephone to your vessel. The Spectrum+ has a telephone directory similar to a cellular phone. Phone numbers have to be preprogrammed into the memory of the radio before this function will operate properly. See section 7.6 Telephone ID setup.

6.7.1 Sending a Ship to Shore Call



1. Press the **CALL/SET** key.
The DSC CALLING menu will appear.
2. Turn the **Channel Selector** knob to select TELEPHONE.
3. Press the **CALL/SET** key.
4. Turn the **Channel Selector** knob to select telephone name you want to contact.
5. Press the **CALL/SET** key.
When the Telephone call signal is sent, the dot-matrix area of the LCD will be as shown in the illustration on the left.
6. When the transceiver receives the telephone call starting signal, the channel is switched to telephone call channel and the alarm will sound. If you receive no acknowledgment signal, refer to 6.7.3 Resend Telephone Call Signal. If you receive Busy signal, refer to 6.7.4 Resend Telephone Call When Receive Busy Signal.
7. To end Telephone Call, press the **CALL/SET** key.
8. When the transceiver has received the telephone call ending signal, the transceiver is switched to the previous channel and the elapsed time will be shown as the illustration on the left.
If no elapsed time data is received, "-- : -- : --" will be shown.

6.7.2 Receiving a Shore to Ship Call

After a DSC Telephone call from a shore station has been received the radio will automatically be switched to the MariTel Marine operator channel.

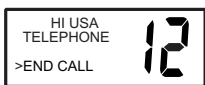

1. When the transceiver receives the telephone call starting signal from the shore, the alarm will sound.

2. To take the incoming call, press the **PTT** and start talking to the person.

3. To end the call, press the **CALL/SET** key.

4. When the transceiver has received the telephone call ending signal, the transceiver is switched to the previous channel and the elapsed time will be shown as the illustration on the left. If no elapsed time data is received "- : - : -" will be shown.

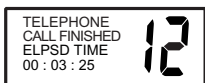

6.7.3 Resend Telephone Call Signal

When you send starting or ending telephone call signal to the coast station and you receive no acknowledgment signal from coast station during 8 seconds or more, Resending menu will appear. You can resend the telephone call with this menu.



1. You receive no acknowledgment signal from coast station, the dot-matrix area of the LCD will be as shown in the illustration on the left.

2. Turn the **Channel Selector** knob to select SEND.

To exit the Telephone Call mode, turn the **Channel Selector** knob to select EXIT and press the **CALL/SET** key.

6.7.4 Resend Telephone Call When Receive Busy Signal

When you send starting telephone call signal to the coast station and you receive Busy signal from coast station, a menu will appear. You can resend the telephone call with this menu.



1. You receive busy signal from coast station, the dot-matrix area of the LCD will be as shown in the illustration on the left.

2. Turn the **Channel Selector** knob to select SEND.

To exit the telephone call, turn the **Channel Selector** knob to select EXIT and press the **CALL/SET** key.

6.8 DSC STANDBY

The DSC Standby function allows the transceiver to reply to DSC calls with the UNATTENDED message and logs the calls in the call waiting directory (This feature is similar to an answering machine). When set to the DSC Standby mode, voice traffic may still be monitored on the selected channel.



1. Press the **CALL/SET** key.
The DSC CALLING menu will appear.



2. Turn the **Channel Selector** knob to select the STANDBY mode.



3. Press the **CALL/SET** key.

4. When an individual DSC call is received, the radio will respond with the UNATTENDED message if an operator cannot answer the call. The DSC call will be logged into the radio's call waiting directory.
5. To cancel this, press the **16/9** key.

NOTE

This function is available as following;
DSC SCAN is turned on, or the current channel is set CH70 if DSC SCAN is turned off.

6.9 CALL WAITING DIRECTORY

The DSC Call Waiting directory logs 10 received distress calls, and logs 20 individual calls that are received and not answered within 5 minutes or while the radio is set on the DSC Standby function. Calls will be logged while busy with other communications as long as the transmitter is not keyed at the time of the call. If the call is answered within 5 minutes the call will not be logged. When a call is logged, a message will appear on the LCD.

NOTE

When a DISTRESS CALL is received, this call will be logged on the distress call waiting directory.

6.9.1 Operation of Distress Call Waiting



1. Press the **CALL/SET** key.
The DSC CALLING menu will appear.



2. Turn the **Channel Selector** knob to select CALL WAIT.



3. Press the **CALL/SET** key.



4. Turn the **Channel Selector** knob to select DISTRESS.

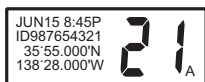

5. Press the **CALL/SET** key to display the log data which was received last.

6. Turn the **Channel Selector** knob to select another logged call

7. To exit from Distress Call Waiting, press the **CALL/SET** key and select EXIT.

6.9.2 Operation of Individual Call Waiting



1. Press the **CALL/SET** key.
The DSC CALLING menu will appear.



2. Turn the **Channel Selector** knob to select CALL WAIT.



3. Press the **CALL/SET** key.



4. Turn the **Channel Selector** knob to select INDIVIDUAL.

5. Press the **CALL/SET** key to enter the individual log.

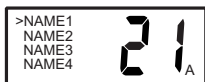

6. Turn the **Channel Selector** knob to select the name.

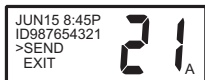

7. Press the **CALL/SET** key to display the logged call.

8. Press the **CALL/SET** key to resend the INDIVIDUAL CALL.
9. To exit from Individual Call Waiting, select EXIT and press the **CALL/SET** key.
10. Turn the **Channel Selector** knob to select another logged call or to select EXIT.
11. Press the **CALL/SET** key to access next logged call or EXIT.

6.10 POSITION REQUEST

The position request mode may be used to show the position of another vessel that has a DSC radio with this feature. The other vessel must have an operating GPS receiver connected to its DSC transceiver and must not have its transceiver set to deny position requests. (Refer the section 7.5 to enter information into the individual directory)



1. Select a traffic channel, then press the **CALL/SET** key. Then the DSC CALLING menu will appear in the display.



2. Turn the **Channel Selector** knob or press the **UP/DOWN** keys on the microphone to select the POS REQUEST.



3. Press **CALL/SET** key to show the Position request directory. This directory uses the INDIVIDUAL Directory information.



4. Turn the **Channel Selector** knob or press the **UP/DOWN** keys on the microphone to select a name.



5. Press the **CALL/SET** key to transmit the position request DSC call.

- After a DSC position request is transmitted, the transceiver remains on channel 70 until position data is received.

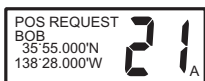

- The transceiver received position data from a vessel.



- If the transceiver does not receive a reply, the LCD will display ">SEND" to prompt the user to send the call again or exit the mode.



- If the transceiver received no position data, the LCD will show "NO POSITION DATA".

- When the transceiver receives the requested position, the transceiver outputs a NMEA DSC sentence which may be used by a Standard Horizon GPS chart plotter to show the vessels position.

6.11 POSITION SEND

The position send mode may be used to send your position to another radio with this feature. Your vessel must have an operating GPS receiver connected to its SPECTRUM+ to send the position and must not have its transceiver set to deny position send.

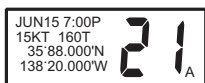

When other vessel receives your position, the transceiver outputs a NMEA DSC sentence which may be used by a Standard Horizon GPS chart plotter to show your position.



- Select a traffic channel, then press the **CALL/SET** key. Then the DSC CALLING menu will appear in the display.



- Turn the **Channel Selector** knob or press the **UP/DOWN** keys on the microphone to select the POS SEND.



- Press the **CALL/SET** key to select the Position send directory. This directory uses the INDIVIDUAL Directory information.



4. Turn the **Channel Selector** knob to select a name.



5. Press the **CALL/SET** key to transmit your position DSC call.



6. After your position DSC is transmitted, the resend menu will appear. When you send your position DSC again, select SEND and press the **CALL/SET** key. When you exit the mode, select EXIT and press the **CALL/SET** key.

7. The transceiver returns to radio mode.

6.12 RECEIVING DSC CALLS

Several types of DSC transmissions can be received. The required action depends on the particular DSC type as outlined in the following examples.

NOTE

If the radio is receiving on a working channel or transmitting on a working channel, DSC calls will not be received.

6.12.1 Receiving a distress call

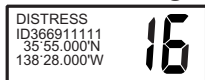

1. A distress call is received. An emergency alarm sounds.

Then channel 16 is automatically selected.

2. Press any key to stop the alarm.

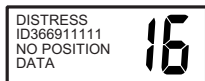

3. If the received distress data does not include the position data, the LCD will show the display on the left.

NOTE

You must continue monitoring channel 16 as a coast station may require assistance in any rescue attempt.

6.12.2 Receiving a distress relay call

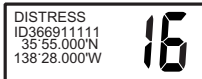

1. A distress relay call is received. An emergency alarm sounds.
Then channel 16 is automatically selected.
2. Press any key to stop the alarm.

NOTE

You must continue monitoring channel 16 as a coast station may require assistance in any rescue attempt.

6.12.3 Receiving an all ships call

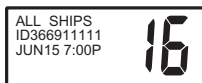

1. An all ships call is received. An emergency alarm sounds.
Then channel 16 is automatically selected.
2. Press any key to stop the alarm.
3. Monitor channel 16 or traffic channel until the URGENCY communication is completed.

6.12.4 Receiving a geographical area call

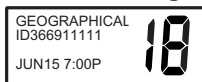

1. A geographical call is received. An emergency alarm sounds (different from DISTRESS). Then the requested channel from the other ship is automatically selected.
2. Press any key to stop the alarm.
3. Monitor the traffic channel for an announcement from the calling ship.

NOTE

This feature is only available when a GPS receiver is connected.

6.12.5 Receiving an individual call

When receiving an individual call, an acknowledgment must be sent back to the calling station.

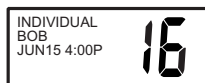

1. An individual call is received. An individual call alarm sounds. Then the radio automatically switches to the requested channel.

2. Press any key to stop the alarm.

3. Press the **PTT** on the mic and talk to the calling ship.

6.12.6. Receiving a position request

When a position request call is received from another vessel, a calling alarm will sound and POS REQUEST will show in the LCD. Operation and transceiver function differs depending on the SET UP POS REPLAY mode setting.

Automatically reply:

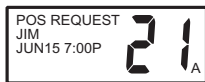

1. When a position request call is received, a calling alarm sounds 4 times. Then requested position coordinates are transmitted automatically.

2. To exit from position request display, press any key.

Manually reply:



1. When a position request call is received, the LCD will be as shown in the illustration on the left.



2. A calling alarm sounds 4 times. Then select type of reply function **REPLY** or **EXIT** by using the **Channel Selector** knob.

3. When **REPLY** is selected, press the **CALL/SET** key. And the requested position coordinates will be transmitted.

4. To exit from position request display, press any key.

7.

DSC / RADIO SETUP MODE

7.1 SETUP



1. Press and hold down the **CALL/SET** key until the SETUP menu appears.
2. To select the items, turn the **Channel Selector** knob.

NOTE

The Optional RAM MIC CMP23 cannot change the SETUP menu. The SETUP menu is displayed in the LCD of the CMP23 as shown in the illustration on the right.

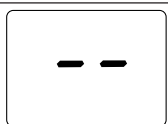

7.2 LAMP ADJUSTING



1. Select LAMP ADJUST in the SETUP menu with the **Channel Selector** knob.



2. Press the **CALL/SET** key. The lamp adjusting menu will appear.



3. Turn the **Channel Selector** knob to select the desired level. When OFF is selected, the lamp is extinguished. When HI is selected, the lamp is brightest.

4. Press the **CALL/SET** key to store the selected level. The LCD will return to the SETUP menu.

7.3 LCD CONTRAST



1. Select CONTRAST in the SETUP menu with the **Channel Selector** knob.



2. Press the **CALL/SET** key. The contrast setting menu will appear. The contrast level can be set from 1 to 7.



3. Turn the **Channel Selector** knob to select the desired level. (Example: 5 is selected)
The contrast is stronger as the selected level increases.

4. Press the **CALL/SET** key to store the selected level.
The LCD will return to the SETUP menu.

7.4 CH NAMING

1. To select USA, INT or CANADA, press and hold the **16/9** key and press **WX** key.



2. Select CH NAME in the SETUP menu (press and hold the **CALL/SET** key) with the **Channel Selector** knob.

3. Press the **CALL/SET** key.



4. Turn the **Channel Selector** knob to select the channel to be named and press the **CALL/SET** key.



5. Turn the **Channel Selector** knob scroll through the alphabet and 0 - 9.



6. Press the **CALL/SET** key to enter the desired letter and move the cursor one space to the right. Repeat procedure until the name is complete. The name can consist of up to twelve characters, if you do not use all twelve character press the **CALL/SET** key to move to the next space. If you clear the previous letter, press the **H/L** key.

7. To enter the name, press the **CALL/SET** key for 1 second or more.



8. If you want to enter the name of another channel, select NEXT and press the **CALL/SET** key. Repeat steps 2 through 6.
To return the Setup menu, select the EXIT and press the **CALL/SET** key.

7.5 INDIVIDUAL DIRECTORY SETUP (DSC)



1. Press and hold the **CALL/SET** key until the **SETUP** menu is displayed.

2. Select **INDIV DIR** by using the **Channel Selector** knob.



3. Press the **CALL/SET** key to enter the individual directory.



4. Turn the **Channel Selector** knob to display the next address number.

(Example: The address number 01 - 04 have been stored in the illustration on the left.)
The address number can be set from 01 to 30.



5. Press the **CALL/SET** key to store the address number.

6. Turn the **Channel Selector** knob scroll through the alphabet and 0 - 9.



7. Press the **CALL/SET** key to enter the desired letter and move the cursor one space to the right. Repeat procedure until the name is complete. The name can consist of up to eleven characters, if you do not use all eleven characters press the **CALL/SET** key to move to the next space. This method can also be used to enter a blank space in the name. To clear the previous letter, press the **H/L** key.

8. After the eleventh letter or space has been entered, press the **CALL/SET** key to advance to the **MMSI** (Maritime Mobile Service Identity Number) number entry.

9. Turn the **Channel Selector** knob to scroll through numbers, 0-9. To enter the desired number and move one space to the right press the **CALL/SET** key. Repeat procedure until all nine space of **MMSI** number are entered.



10. After entering the MMSI number press and hold the **CALL/SET** key until the screen prompts you to select **NEXT** or **EXIT**.

11. To enter another individual address select **NEXT** with the **Channel Selector** knob and press the **CALL/SET** key. Repeat steps 4 through 10.

12. To exit the individual directory setup, select **EXIT** with the **Channel Selector** knob and press the **CALL/SET** key.

NOTE

Selecting **NEXT** or **EXIT** will automatically save the name and MMSI number into memory.

7.6 DSC TELEPHONE DIRECTORY ID INPUT



1. Press and hold the **CALL/SET** key until the **SETUP** menu is displayed.

2. Select **TELEPHONE** with the **Channel Selector** knob and press the **CALL/SET** key.



3. Select the desired memory address with the **Channel Selector** knob and press the **CALL/SET** key.



4. To enter the letter of the name, turn the **Channel Selector** knob, scroll through the alphabet and 0 - 9 and press the **CALL/SET** key. Repeat procedure until the name is complete. The name can consist of up to eleven characters.



5. A cursor will be moved to the telephone number section when the name is entered up to eleven characters.



6. To enter the telephone number, turn the **Channel Selector** knob scroll through the 0 - 9 and press the **CALL/SET** key. Repeat procedure until the telephone number is complete. The telephone number can consist of up to 16 digits.



The display will show up to 12 digits, when you enter 13 digits or more, the arrow symbol will appear. Press and hold the **CALL/SET** key to store the telephone number.

7. Press and hold the **CALL/SET** key until Coast MMSI is displayed.



8. To enter the Coast MMSI, turn the **Channel Selector** knob scroll through the 0 - 9 and press the **CALL/SET** key. Repeat procedure until the Coast MMSI is complete. The Coast MMSI can consist of up to nine digits.

9. To store Coast MMSI, press the **CALL/SET** key for 1 second or more.



10. To enter another Telephone Memory ID, select NEXT and press the **CALL/SET** key. Repeat steps 3 through 8. Up to 30 Telephone ID numbers can be entered.

To return the Setup menu, select EXIT and press the **CALL/SET** key.

NOTE

Refer to the section 9.3 MAKING TELEPHONE CALLS.

7.7 POSITION REQUEST REPLY TYPE

1. Press and hold the **CALL/SET** key until the SETUP menu is displayed.



2. Select POS REPLY in the SETUP menu with the **Channel Selector** knob.



3. Press the **CALL/SET** key. The position request reply type menu will appear.

4. Press the **Channel Selector** knob to select AUTO or MANUAL. In AUTO mode, after a DSC POS Request is received the radio will automatically transmit your vessels position. In MANUAL mode, the display of the SPECTRUM+ will show who is requesting the position. To send your position, you will have to press the **CALL/SET** key.

5. Press the **CALL/SET** key to store a selected reply type. The LCD display will return to the SETUP menu.

7.8 VOICE SCRAMBLER

1. Press and hold the **CALL/SET** key until the SETUP menu is displayed.



2. Select SCRAMBLER in the SETUP menu with the **Channel Selector** knob.



3. Press the **CALL/SET** key.
The scrambler setup menu will appear.

4. Select CODE in the SCRAMBLER SETUP menu and press the **CALL/SET** key.



5. Turn the **Channel Selector** knob to change the scrambler code.
The scrambler code can be set from 0 to 3.

6. Press the **CALL/SET** key to store the selected code.
The LCD will return the SCRAMBLER SETUP menu.



7. Select CHANNEL in the SCRAMBLER SET UP menu and press the **CALL/SET** key.



8. Turn the **Channel Selector** knob to change the scrambled channel.



9. Press the **CALL/SET** key to store the selected channel.
Repeat steps 8 and 9 to set other channels.

10. Press and hold down the **CALL/SET** key to exit from the channel select menu.
The LCD will return to the SCRAMBLER SETUP menu.



11. Select ON to use the scrambler operation and press the **CALL/SET** key.
The LCD will return to the SETUP menu.

NOTE

This menu will not appear unless a CVS2500 is installed.

7.9 KEY BEEP (ON OR OFF)

1. Press and hold the **CALL/SET** key until the SETUP menu is displayed.



2. Select KEY BEEP in the SETUP menu with the **Channel Selector** knob.



3. Press the **CALL/SET** key.
The KEY BEEP setting menu will appear.

4. Turn the **Channel Selector** knob to select ON or OFF.
5. Press the **CALL/SET** key to set the key beep condition.
The LCD will return to the SETUP menu.

NOTE

Emergency alarm and beeps for DSC operation cannot be turned OFF.

7.10 INDIVIDUAL RING

1. Press and hold the **CALL/SET** key until the SETUP menu is displayed.



2. Select INDIV RING in the SETUP menu with the **Channel Selector** knob.



3. Press the **CALL/SET** key.
The INDIVIDUAL RING setting menu will appear.

4. Turn the **Channel Selector** knob to select the ringing time for an INDIVIDUAL CALL. DEFAULT setting rings for 3 minutes continuously.
5. Press the **CALL/SET** key to store the INDIV RING.
The LCD will return to the SETUP menu.

7.11 TIME OFFSET

Sets the time difference between local time and UTC. Time is displayed when position (LAT/LON) is displayed by pressing the **NAV** key.

1. Press and hold the **CALL/SET** key until the SETUP menu is displayed.



2. Select TIME SET in the SETUP menu with the **Channel Selector** knob.



3. Press the **CALL/SET** key. The time offset menu appears.



4. Turn the **Channel Selector** knob to select time offset from UTC. See Figure 4 to find your offset time from UTC. If 0:00 is assigned, the time is the same as UTC (Universal Time Coordinated or GMT Greenwich Mean Time)

5. Press the **CALL/SET** key to store the time offset. The LCD will return to the SETUP menu.

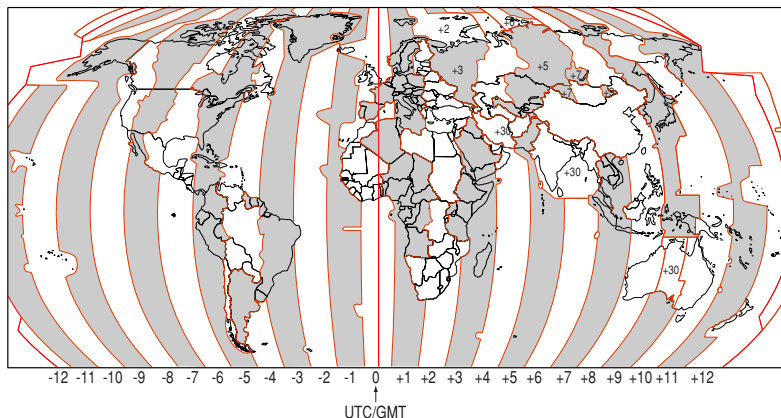

Figure 4. Offset time table

7.12 USER MMSI INPUT

1. Press and hold the **CALL/SET** key until the SETUP menu is displayed.



2. Select the USER MMSI in the SETUP menu with the **Channel Selector** knob.

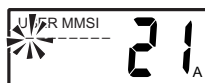

3. Press the **CALL/SET** key.
The USER MMSI menu will appear, and the first space will blink.



4. Turn the **Channel Selector** knob to set the number (0 to 9).



5. Press the **CALL/SET** key to store the set number.
The blinking number is stored, and the next space will blink. To delete previous letter, press the **H/L** key.



6. Repeat steps 3 and 4 to set your MMSI.

7. When the last number of your MMSI is in place, press the **CALL/SET** key to store your MMSI.

NOTE

User MMSI can be input only twice. If the user tries to input MMSI more than twice, the radio will show the display on the right. If the user needs to change the MMSI more than twice, the transceiver will have to be sent to Factory Service. Refer to the section 10.2 FACTORY SERVICE.



7.13 GROUP MMSI INPUT

1. Press and hold the **CALL/SET** key until the SETUP menu is displayed.



2. Select the GROUP MMSI in the SETUP menu with the **Channel Selector** knob.

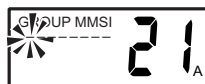

3. Press the **CALL/SET** key.
The GROUP MMSI menu will appear, and the first space will blink.

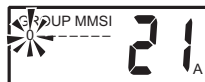

4. Turn the **Channel Selector** knob to set the number (0 to 9).



5. Press the **CALL/SET** key to store the set number.
The blinking number is stored, and the next space will blink.



6. Repeat steps 3 and 4 to set your GROUP MMSI.

7. When the last number of your MMSI is in place, press and hold down the **CALL/SET** key to store your MMSI.

7.14 DSC SCANNING

The radios software has been updated to improve DSC Channel 70 SCANNING:

1. When a DSC call is received the radio will only show Channel 70 on the display if the call was directed to the radios MMSI or if it is a Distress or All ships DSC call.
2. Selection to turn ON or OFF the DSC SCAN function.

When the radio is shipped from the factory it is programmed so CH70 (the DSC channel) is scanned at all times. A selection has been added to the SETUP MENU in the radio to disable the DSC SCAN. However, turning off DSC SCAN will disable the radio from receiving DSC calls i.e.: Individual Call, All Ships Call, Distress Call and Position Requests. If you want to use any of the functions the selection should be left ON.

TO CHANGE DSC SCAN METHOD:

1. Press and hold the CALL/SET key to enter into the SETUP mode.



2. Select DSC SCAN using the **Channel Selector** knob.



3. Press the **CALL/SET** key. The DSC SCAN setting menu will appear.

4. Turn the **Channel Selector** knob to select ON or OFF.
5. To store the selection, press the **CALL/SET** key. The LCD will return to the SETUP menu.

If the optional RAM Mic (CMP23) is connected to the remote microphone connector on the transceiver's rear panel, then the transceiver can use the remote control operation except for a few functions. The RAM Mic has a maximum range of 50 feet (15 m) with the use of two 10-foot extension cables (CAW23). The intercom operation can be used between the RAM Mic and the transceiver.

8.1 RAM MIC CONTROLS AND CONNECTIONS

POWER SWITCH (PWR)

Turns the transceiver on and off.

Press and hold down the **PWR** key until the LCD turns on. To turn the transceiver off with the RAM Mic, press and hold the **PWR** key until the LCD turns off.

SQUELCH KEY (SQL)

Activates the squelch adjusting mode.

Press this key to activate the squelch adjusting mode. Press the ▲ or ▼ key to adjust the squelch.

Sets the point at which random noise on the channel does not activate the audio circuits but a received signal does. This point is called the "squelch threshold". Further adjustment of the squelch control by pressing the ▲ key will degrade the reception of wanted transmissions.

When the **SQL** key is pressed and held down for 1 second or more, the squelch is turned off.

VOLUME KEY (VOL)

Activates the volume adjusting mode.

Press this key to activate the volume adjusting mode. Press the ▲ or ▼ key to adjust the volume.

PTT (Push-To-Talk) SWITCH

Activates transmission.

16/9 KEY

Immediately recalls channel 16 from any channel location. Press and hold the **16/9** key to recall channel 9. Recalls the previous channel when the **16/9** key is pressed again. When holding down the **16/9** key while pressing the **WX** key, the mode toggles between USA, International and Canadian.

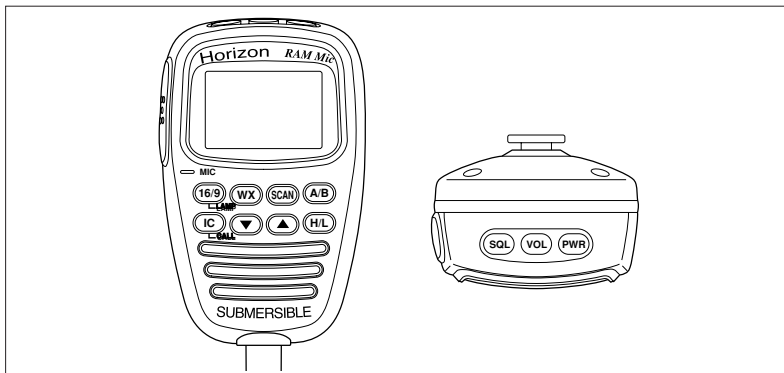

Figure 5. CMP23 RAM Mic

A/B Key

Immediately recalls two user assigned channels from any channel.

IC Key

Activates the intercom mode between the RAM Mic and the transceiver. Refer to section 8.3, INTERCOM OPERATION.

WX Key

Immediately recalls a weather channel from any channel location. Recalls the previous channel when the **WX** key is pressed again.

Secondary use

When holding down the **16/9** key while pressing the **WX** key, the mode toggles between USA, International and Canadian.

SCAN Key

1. Starts and stops scanning of programmed channels.
2. If held while the UP or DOWN key is pressed, the radio will show the channels in scan memory. This function will not work if the unit is scanning.

Secondary use

Press the **MEM** key to add the selected channel to the transceiver's scan memory, MEM will appear on the LCD to indicate that the channel has been entered into scan memory. To delete the channel from scan memory, press the **MEM** key until the MEM disappears from the LCD.

NOTE

If the transceiver is in the M-SCAN mode, then the RAM Mic is in SC mode. If the transceiver is in P-SCAN mode, then the RAM Mic is in PS mode.

DOWN KEY (▼)

Selects the desired channel and adjusts the volume and squelch levels. Each press decreases the channel number, volume level and squelch level. When held down, the channels or levels decrease continuously.

UP KEY (▲)

Selects the desired channel and adjusts the volume and squelch levels. Each press increases the channel number, volume level, and squelch level. When held down, the channels or levels increase continuously.

Secondary use

When holding down the **16/9** key while pressing the **UP ▲** key, changes the brightness (3 levels) of the LCD back light.

H/L KEY

Toggles between high and low power. When the **H/L** key is pressed while the transceiver is on Canadian channel 13, USA channel 13 or 67, the power will temporarily switch from LO to HI power until the **PTT** switch is pressed. The **H/L** key does not function on transmit-inhibited and low power-only channels.

8.2 INDICATORS

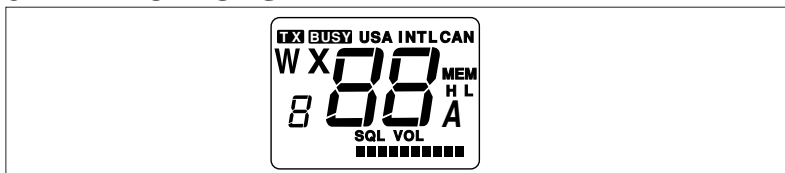

Channel Display

Displays the operating channel in both transmission and reception mode.

A Indicator

A simplex channel in USA or Canadian mode whose counterpart in the International mode is a duplex channel.

TX/ BUSY Indicator

“TX” is displayed in transmitting mode. “BUSY” is displayed in receiving mode.

USA/ INTL/ CAN Indicator

The mode of operation. “USA” indicates USA mode. “INTL” indicates International mode and “CAN” indicates Canadian mode.

WX Indicator

A weather channel.

MEM Indicator

The channel is in the transceiver's scan memory.

H/L Indicator

"H" is high power. "L" is low power. Blank is a reception only channel.

SQL/VOL Indicator

"SQL" is squelch adjusting mode. "VOL" is volume adjusting mode.

8.3 INTERCOM OPERATION

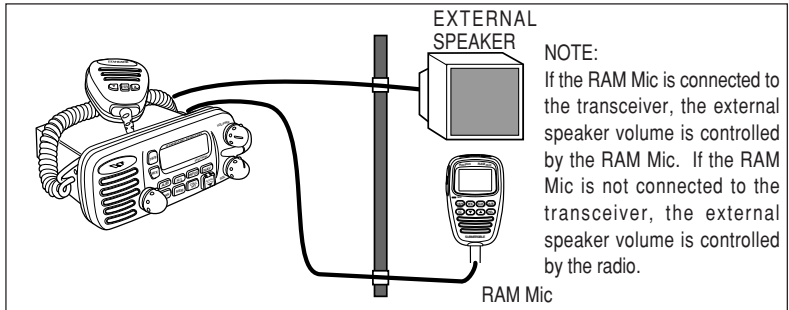

Figure 6. Intercom operation

8.3.1 Communication

1. Press the **IC** key while in radio mode, the mode is then changed to INTERCOM mode. If the **IC** key is pressed again the mode will revert to radio mode.
2. "IC" is displayed on both the transceiver and the RAM Mic when the intercom operation is activated.
3. Press the **PTT** switch. The "TX" indicator is displayed.

NOTE

A warning beep is emitted when the RAM Mic **PTT** switch is pressed while the transceiver microphone's **PTT** switch is pressed.

4. Speak slowly and clearly into the microphone, hold the microphone about 1/2 inch away from your mouth.
5. When finished, release the **PTT** switch.

8.3.2 Calling

1. Hold down the **IC** key in the intercom operation for 1 second or more. A calling beep is emitted twice from the transceiver speaker.

9.1 EMERGENCY (CHANNEL 16 USE)

Channel 16 is known as the *Hail and Distress Channel*. An emergency may be defined as a threat to life or property. In such instances, be sure the transceiver is on and set to CHANNEL 16. Then use the following procedure:

1. Press the microphone push-to-talk switch and say "**Mayday, Mayday, Mayday**. This is _____, _____, _____" (your vessel's name).
2. Then repeat once: "**Mayday, _____,**" (your vessel's name).
3. Now report your position in latitude/longitude, or by giving a true or magnetic bearing (state which) to a well-known landmark such as a navigation aid or geographic feature such as an island or harbor entry.
4. Explain the nature of your distress (sinking, collision, aground, fire, heart attack, life-threatening injury, etc.).
5. State the kind of assistance your desire (pumps, medical aid, etc.).
6. Report the number of persons aboard and condition of any injured.
7. Estimate the present seaworthiness and condition of your vessel.
8. Give your vessel's description: length, design (power or sail), color and other distinguishing marks. The total transmission should not exceed 1 minute.
9. End the message by saying "**OVER**". Release the microphone button and listen.
10. If there is no answer, repeat the above procedure. If there is still no response, try another channel.

9.2 CALLING ANOTHER VESSEL (CHANNEL 16 OR 9)

Channel 16 may be used for initial contact (hailing) with another vessel. However, its most important use is for emergency messages. This channel must be monitored at all times except when actually using another channel. It is monitored by the U.S. and Canadian Coast Guards and by other vessels. **Use of channel 16 for hailing must be limited to initial contact only.** Calling should not exceed 30 seconds, but may be repeated 3 times at 2-minute intervals. In areas of heavy radio traffic, congestion on channel 16 resulting from its use as a hailing channel can be reduced significantly in U.S. waters by using **channel 9** as the initial contact (hailing) channel for non-emergency communications. Here, also, calling time should not exceed 30 seconds but may be repeated 3 times at 2-minute intervals.

Prior to making contact with another vessel, refer to the channel charts in this manual, and select an appropriate channel for communications after initial contact. For example, Channels 68 and 69 of the U.S. VHF Charts are some of the channels available to non-commercial (recreational) boaters. Monitor your desired channel in advance to make sure you will not be interrupting other traffic, and then go back to either channel 16 or 9 for your initial contact.

When the hailing channel (16 or 9) is clear, state the name of the other vessel you wish to call and then **“this is”** followed by the name of your vessel and your Station License (Call Sign). When the other vessel returns your call, immediately request another channel by saying **“go to”**, the number of the other channel, and "over." Then switch to the new channel. When the new channel is not busy, call the other vessel.

After a transmission, say **“over”**, and release the microphone's push-to-talk (PTT) switch. When all communication with the other vessel is completed, end the last transmission by stating your Call Sign and the word **“out”**. Note that it is not necessary to state your Call Sign with each transmission, only at the beginning and end of the contact.

Remember to return to Channel 16 when not using another channel. Some radios automatically monitor Channel 16 even when set to other channels or when scanning; see your Owner's Manual.

9.3 MAKING TELEPHONE CALLS

To make a radiotelephone call, use a channel designated for this purpose. The fastest way to learn which channels are used for radiotelephone traffic is to ask at a local marina. Channels available for such traffic are designated **Public Correspondence** channels on the channel charts in this manual. Some examples for USA use are Channels 24, 25, 26, 27, 28, 84, 85, 86, and 87. Call the marine operator and identify yourself by your vessel's name. The marine operator will then ask you how you will pay for the call (telephone credit card, collect, etc.) and then link your radio transmission to the telephone lines.

The marine telephone company managing the VHF channel you are using may charge a link-up fee in addition to the cost of the call.

9.4 OPERATING ON CHANNELS 13 AND 67

Channel 13 is used at docks and bridges and by vessels maneuvering in port. Messages on this channel must concern navigation only, such as meeting and passing in restricted waters.

Channel 67 is used for navigational traffic between vessels.

By regulation, power is normally limited to 1 Watt on these channels. Your radio is programmed to automatically reduce power to this limit on these channels. However, in certain situations it may be necessary to temporarily use a higher power. See page 8 (H/L key) for means to temporarily override the low-power limit on these two channels.

9.5 PROHIBITED COMMUNICATIONS

The FCC prohibits the following communications:

- False distress or emergency messages;
- Messages to "any boat" except in emergencies and radio tests;
- Messages to or from a vessel on land;
- Transmission while on land;
- Obscene, indecent, or profane language (potential fine of \$10,000).

9.6 NOAA WEATHER ALERT TESTING

In the event of a major storm or other appreciable weather condition requiring vessels at sea or other bodies of water to be notified, the NOAA (National Oceanographic and Atmospheric Administration) broadcasts a 1050 Hz tone that some marine VHF radios can detect. (Refer to Section 5.7 "NOAA WEATHER ALERT" on how to use this feature.) This tone, when detected, will produce a loud beep from the radio speaker to signal that a weather alert is being broadcast.

In order to test this system, the NOAA broadcasts the 1050 Hz tone every Wednesday, sometime between 11 AM and 1 PM. Any marine VHF radio that can detect the weather alert tone, may use this test to verify that this feature is functioning properly,

9.7 DIGITAL SELECTIVE CALLING (DSC)

Digital Selective Calling is a semi-automated method of establishing a radio call, it has been designated by the International Maritime Organization (IMO) as an international standard for establishing VHF, MF and HF radio calls. It has also been designated part of the Global Maritime Distress and Safety System (GMDSS) and it is planned that DSC will eventually replace aural watches on distress frequencies and will be used to announce routine and urgent maritime safety information broadcasts.

This new service will allow mariners to instantly send a distress call with GPS position (when connected to the transceiver) to the US Coast Guard and other vessels within range of the transmission. DSC will also allow mariners to initiate or receive distress, urgency, safety and routine calls to or from another vessel equipped with a DSC transceiver.

9.7.1 USCG DSC Watch

The USCG has plans to upgrade its VHF National Distress System (expected by 2005), so at the time of printing only larger vessels that are required to carry VHF DSC radios will be able to hear your distress transmission

9.8 MARITIME MOBILE SERVICE IDENTITY (MMSI)

9.8.1 What is a MMSI?

A MMSI is a nine digit number used on Marine Transceivers capable of using Digital Selective Calling (DSC). This number is used like a telephone number to selectively call other vessels.

9.9 USING DIGITAL SELECTIVE CALLING FEATURES

9.9.1 Distress Call

Transmits a DSC Distress message to all radios equipped to receive a DSC Distress call. Some Standard Horizon radios may be connected to a GPS to also transmit the Latitude, Longitude of the vessel.

9.9.2 Individual Call

This feature allows the user to contact another vessel capable of using DSC and automatically switch the radio to a desired working channel. This feature is similar to calling a desired vessel on CH16 and requesting them to go to another channel.

9.9.3 Group Call

This feature allows the user to contact a group or vessels capable of using DSC to automatically switch the radios to a desired working channel for voice communication.

9.9.4 Urgency Call

This call should be used when a vessel may not be truly in distress, but have a potential problem that might lead to a distress situation.

9.9.5 Safety Call

Used to transmit boating safety information to other vessels. This message usually contains information about an overdue boat, a derelict afloat, loss of a navigation aid or an important meteorological message.

9.9.6 Position request

Used to poll another vessel position via DSC and show it on the LCD of the radio.

9.9.7 Telephone Call

Used to automatically place a telephone call through a shore based telephone company. (In the U.S. market contact maritel at 1866 - marinet for subscription details)

9.10 ADDITIONAL DIGITAL SELECTIVE CALLING INFORMATION

For additional information the USCG has an excellent site that should be visited at www.navcen.uscg.mil/marcoms/gmdss/dsc.html

9.11 ABOUT VHF RADIO

The radio frequencies used in the VHF marine band lie between 156 and 158 MHz with some shore stations available between 161 and 163 MHz. The marine VHF band provides communications over distances that are essentially "line of sight" (VHF signals do not travel well through objects such as buildings, hills or trees). Actual transmission range depends much more on antenna type, gain and height than on the power output of the transmitter. On a fixed mount 25W radio transmission expected distances can be greater than 15 miles, for a portable 5W radio transmission the expected distance can be greater than 5 miles in "line of sight".

9.12 SELECTING AN ANTENNA

Marine antennas are made to radiate signals equally in all horizontal directions, but not straight up. The objective of a marine antenna is to enhance the signal toward the horizon. The degree to which this is accomplished is called the antenna's gain. It is measured in decibels (dB) and is one of the major factors in choosing an antenna. In terms of effective radiated power (ERP), antennas are rated on the basis of how much gain they have over a theoretical antenna with zero gain. A 3 foot, 3dB gain antenna represents twice as much gain over the imaginary antenna. The length of the antenna you choose, however, must also be related to the size of your boat.

Typically a 3 foot 3dB gain stainless steel whip is used on a sailboat mast. The longer 8 foot 6dB fiberglass whip is primarily used on power boats that require the additional gain.

9.13 COAXIAL CABLE

VHF antennas are connected to the transceiver by means of a coaxial cable – a shielded transmission line. Coaxial cable is specified by its diameter and construction. For runs less than 20 feet, RG-58/U, about 1/4 inch in diameter is a good choice. For runs over 20 feet but less than 50 feet, the larger RG-8 or RG-213/U should be used for cable runs over 50 feet RG-8 should be used. For installation of the connector onto the coaxial cable refer to the figure below.

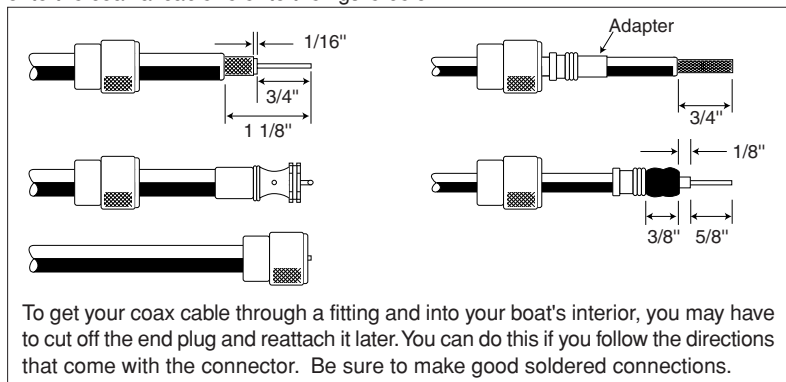

The inherent quality of the solid-state components used in this transceiver will provide many years of continuous use. Taking the following precautions will prevent damage to the transceiver.

- * Never key the microphone unless an antenna or suitable dummy load is connected to the transceiver.
- * Ensure that the supply voltage to the transceiver does not exceed 16 VDC or fall below 11 VDC.

In the unlikely event of serious problems, please contact your Dealer or our repair facility. Address and phone numbers for this facility, as well as warranty information, are contained in the section 12 WARRANTY.

10.1 REPLACEMENT PARTS

Occasionally an owner needs a replacement mounting bracket or knob. These can be ordered from our Parts Department by writing or calling:

Marine Division of Vertex Standard
 US Headquarters
 17210 Edwards Rd., Cerritos, CA 90703

Commonly requested parts, and their part numbers are listed below.

Microphone, White (CMP351W)	MP51000400
Microphone, Black (CMP351B)	MP51000410
RAM Microphone Connector Cover	389B053010
Mounting Bracket, White	444X160030
Mounting Bracket, Black	444X160130
Mounting Bracket Knob, White	444X154030
Mounting Bracket Knob, Black	444X154130
Volume Control Knob	443X154500
Squelch Control Knob	443X154500
Accessory Cable	ZD00600090
Power Cord	ZC01300010
Mic Hanger, White	277X155020
Mic Hanger, Black	277X155120
Dust Cover	03AX053010



10.2 FACTORY SERVICE

In the unlikely event that the radio fails to perform or needs servicing, please contact the following:

Standard Horizon Factory Service
115 North Wright Brothers Drive
Salt Lake City, UT 84116-2838
Telephone (800) 366-4566
Fax No. (801) 359-4122

An "RA" Return Authorization number is not necessary to send a product in for service. Include a brief note describing the problem along with your name, return address, phone number, and proof of purchase.

10.3 TROUBLESHOOTING CHART

TROUBLESHOOTING CHART		
SYMPTOM	PROBABLE CAUSE	REMEDY
Transceiver fails to power up.	No DC voltage to the transceiver, or blown fuse.	Press and hold the Power switch/ Volume control knob until the transceiver turns on. Check the power cable for DC voltage, or replace the fuse (6A 250V).
Transceiver blows fuse when connected to power supply.	Reversed power wires.	Make sure the red wire is connected to the positive battery post and the black wire is connected to the negative. If the fuse still blows, contact your Dealer.
Popping or whining noise from the speaker while engine runs.	Engine noise.	Reroute the DC power cables away from the engine. Add noise suppressor on power cable. Change to resistive spark plug wires and/or add an alternator whine filter.
Sound is not emitted from the external speaker.	External cable	Check the polarity of the connected external cable.
Receiving stations report low transmit power, even with transceiver set to HI power.	Antenna.	Have the antenna checked or test the transceiver with another antenna. If the problem persists, contact your Dealer for servicing.
<p>"HI BATTERY" or "LOW BATTERY" is displayed when the power is turned on.</p> 	The power supply voltage is too high or too low.	Confirm that the connected power supply voltage is not 24 volts or lower than 9 volts. Confirm that the generator has not malfunctioned.
<p>Your position is not displayed.</p>  	External cable.	Check the polarity of the connected external cable. Some GPS use the battery ground line for NMEA connection.
	Setting of the GPS navigation receiver.	Check the output signal format of the GPS navigation receiver. This radio requires NMEA0183 format with GLL sentence as an output signal. If the GPS has a baud rate setting make sure to select 4800 and parity to NONE

10.4 CONNECTION OF GPS WITH NMEA OUTPUT

Manufacturer / Model	Wires	SPECTRUM+
STANDARD HORIZON	Green	Brown/Green
CP150, CP160 and CP170C	Blue	Gray
	Brown	Blue
Furuno GP30, 36	White	Blue
	Blue	Green
Furuno GP1650, 1850	White	Blue
	Black	Green
Garmin Fixed Mounts	Blue	Blue
	Black (ground)	Green
Garmin Portables	Brown	Blue
	Black (ground)	Green
JRC GPS500	Yellow	Blue
	Green	Green
JRC 100 SERIES	Green	Blue
	Black	Green
JRC 200 SERIES	White	Blue
	Black	Green
Lowrance Fixed Mount	White	Blue
	Black (ground)	Green
Lowrance Portable	Orange	Blue
	Black (ground)	Green
Magellan Fixed Mount	Gray	Blue
	Black (ground)	Green
Magellan Portable	Orange	Blue
	Black (ground)	Green
Northstar	Yellow	Blue
	Black (ground)	Green
Raytheon 420	Yellow	Blue
	Brown	Green
Raytheon 520 / 620	Blue	Blue
	Brown	Green
Raytheon RL SERIES	White	Blue
	Brown	Green
Simrad	White	Blue
	Brown	Green
Sitex Neptune, Nautilus	Gray	Blue
	Brown	Green

Additional Information:

- The GPS must have the NMEA Output turned on and set to 4800 Baud in the setup menu. If there is a selection for parity select none.
- For further information on interfacing /setting up your GPS. Please contact the manufacturer of the GPS receiver.

If you have further inquires, please feel free to contact us at:

Phone: (800) 767-2450

Fax: (562) 926-2497

Web site: standardhorizon.com

Email: marinetech@vxstdusa.com

11.

CHANNEL ASSIGNMENTS

Tables on the following columns list the VHF Marine Channel assignments for U.S.A., Canada and International use. Below are listed some data about the charts.

1. VTS. Where indicated, these channels are part of the U.S. Coast Guard's **Vessel Traffic System**.

2. Alpha channel numbers, that is, channel numbers followed by the letter A (such as Channel 07**A**) are **simplex** channels on the U.S.A. or Canadian channel assignments whose counterparts in the International assignments are **duplex** channels. International channels do not use "alpha" numbers. If you call the Coast Guard on Channel 16, they will sometimes ask you to **"go to channel 22 Alpha."** This is a channel assigned to U.S.A. and Canadian Coast Guards for handling distress and other calls. If your radio is set for **International** operation you will go to Channel 22 instead of 22**A**, and will not be able to communicate with the Coast Guard. To use Channel 22**A**, your radio must be set for **USA** or **Canada** operation, usually by a U/I/C (USA/International/Canada) control or combination of controls. Channel 22 (without an "A") is an **International** duplex channel for port operations. Some radios indicate an "A" adjacent to the alpha channels on the display; on others "alpha" is not indicated but the proper channel is selected based on the U/I/C setting.

3. Bridge-to-Bridge channels (for example, Channel 13) are for use by bridge operators on intercoastal waterways and rivers. It is also used by marine vessels in the vicinity of these bridges for navigation and for communicating with the bridge operators. **Note that a limit of 1 Watt is specified for these channels.** See page 51 for additional information.

4. The **S/D** column on the chart indicates either S (simplex) or D (duplex). **Simplex** means transmitting and receiving on the same frequency. Only one party at a time can talk, unlike a telephone. Be sure to say **"over"** and release your microphone push-to-talk switch at the end of each transmission. **Duplex** operation involves the use of one frequency for transmitting and a separate frequency for receiving. On channels specified as duplex on the charts, correct mode of operation is established automatically by your radio when you select a channel; you cannot change the mode. And you still must release the push-to-talk switch after each transmission in order to listen to the radio.

5. Channels normally used by recreational boaters are those that include the term "non-commercial" in the **Channel Use** column of the chart. Some of these are shared with other users and some are used only in certain geographic regions. The Marine Radio – Telephone User's Handbook identifies shared channels in details.

6. Marine vessels equipped with VHF radios are required to monitor Channel 16.

VHF MARINE CHANNEL CHART							
CH	U	C	I	S/D	TX	RX	CHANNEL USE
01		X	X	D	156.050	160.650	Public Correspondence (Marine Operator)
01A	X			S	156.050		Port Operation and Commercial. VTS in selected areas
02		X	X	D	156.100	160.700	Public Correspondence (Marine Operator)
03		X	X	D	156.150	160.750	Public Correspondence (Marine Operator)
03A	X			S	156.150		US Government only, Coast Guard
04			X	D	156.200	160.800	Public Correspondence (Marine Operator), Port operation, ship movement
04A	X			S	156.200		Pacific coast: Coast Guard, East Coast: Commercial fishing
05A	X	X		S	156.250		Port operation. VTS in Seattle.
05			X	D	156.250	160.850	Public Correspondence (Marine Operator), Port operation, ship movement
06	X	X	X	S	156.300		Inter-ship Safety
07			X	D	156.350	160.950	Public Correspondence (Marine Operator), Port operation, ship movement
07A	X	X		S	156.350		Commercial
08	X	X	X	S	156.400		Commercial (Inter-ship only)
09	X	X	X	S	156.450		Boater Calling channel, Commercial & Non-commercial (Recreational)
10	X	X	X	S	156.500		Commercial
11	X	X	X	S	156.550		Commercial. VTS in selected areas.
12	X	X	X	S	156.600		Port operation. VTS in selected areas.
13	X	X	X	S	156.650		Inter-ship Navigation Safety (Bridge-to-bridge)
14	X	X	X	S	156.700		Port operation. VTS in selected areas.
15	X			S	---	156.750	Environmental (Receive only)
15		X	X	S	156.750		Commercial, non-commercial, ship movement (1W)
16	X	X	X	S	156.800		International Distress, Safety and Calling.
17	X	X	X	S	156.850		State Controlled (1 W)
18			X	D	156.900	161.500	Port operation, ship movement
18A	X	X		S	156.900		Commercial
19			X	D	156.950	161.550	Port operation, ship movement
19A	X			S	156.950		US: Commercial
19A		X		S	156.950		Coast Guard
20	X		X	D	157.000	161.600	Canadian Coast Guard Only, International: port operations and shipment
20		X		D	157.000	161.600	Canadian Coast Guard Only, International: port operations and shipment (1 W)
20A	X			S	157.000		Port Operation
21			X	D	157.050	161.650	Port operation, ship movement
21A	X	X		S	157.050		U.S. Government Only, Canadian Coast Guard
22			X	D	157.100	161.700	Port operation, ship movement
22A	X	X		S	157.100		US and Canadian Coast Guard Liaison and Maritime Safety Information Broadcasts announced on channel 16
23		X	X	D	157.150	161.750	Public Correspondence (Marine Operator)
23A	X			S	157.150		U.S. Government Only
24	X	X	X	D	157.200	161.800	Public Correspondence (Marine Operator)
25	X	X	X	D	157.250	161.850	Public Correspondence (Marine Operator)
26	X	X	X	D	157.300	161.900	Public Correspondence (Marine Operator)
27	X	X	X	D	157.350	161.950	Public Correspondence (Marine Operator)
28	X	X	X	D	157.400	162.000	Public Correspondence (Marine Operator)

VHF MARINE CHANNEL CHART

CH	U	C	I	S/D	TX	RX	CHANNEL USE
60		X	X	D	156.025	160.625	Public Correspondence (Marine Operator)
61			X	D	156.075	160.675	Public Correspondence (Marine Operator), Port operation, ship movement
61A	X	X		S	156.075		U.S. Government Only, Canadian Coast Guard-Pacific Coast, Commercial Fishing-East Coast
62			X	D	156.125	160.725	Public Correspondence (Marine Operator), Port operation, ship movement
62A		X		S	156.125		Pacific Coast: Coast Guard; East Coast: commercial fishing only
63			X	D	156.175	160.775	Public Correspondence (Marine Operator), Port operation, ship movement
63A	X			S	156.175		Port Operation and Commercial. VTS in selected areas.
64		X	X	D	156.225	160.825	Public Correspondence (Marine Operator), Port operation, ship movement
64A	X	X		S	156.225		U.S. Government Only, Canadian Commercial Fishing
65			X	D	156.275	160.875	Public Correspondence (Marine Operator), Port operation, ship movement
65A	X	X		S	156.275		Port Operations
66			X	D	156.325	160.925	Public Correspondence (Marine Operator), Port operation, ship movement
66A	X			S	156.325		Port Operations
66A		X		S	156.325		Port Operations (1W)
67	X	X	X	S	156.375		US: Commercial. Used for Bridge-to-bridge communications in lower Mississippi River. Inter-ship only, Canada: Commercial fishing, S&R
68	X	X	X	S	156.425		Non-commercial (Recreational)
69	X	X	X	S	156.475		US: Non-commercial (Recreational), Canada: Commercial fishing only. International: Port operations and Ship movement
70	X	X	X	S	156.525		Digital selective calling (voice communications not allowed)
71	X	X	X	S	156.575		US, Canada: Non-commercial (Recreational), International: Port operations and Ship movement
72	X	X	X	S	156.625		Non-commercial (Inter-ship only)
73	X	X	X	S	156.675		US: Port Operations, Canada: Commercial fishing only, International: Inter-ship, Port operations and Ship movement
74	X	X	X	S	156.725		US: Port Operations, Canada: Commercial fishing only, International: Inter-ship, Port operations and Ship movement
77	X	X		S	156.875		Port Operations (inter-ship only) (1 W)
77			X	S	156.875		Port Operations (inter-ship only)
78			X	D	156.925	161.525	Public Correspondence (Marine Operator), Port operation, ship movement
78A	X	X		S	156.925		Non-commercial(Recreational)
79			X	D	156.975	161.575	Port operation and Ship movement
79A	X	X		S	156.975		Commercial
80			X	D	157.025	161.625	Port operation, ship movement
80A	X	X		S	157.025		Commercial
81			X	D	157.075	161.675	Port operation, ship movement
81A	X	X		S	157.075		U.S. Government Only – Environmental protection operations.
82			X	D	157.125	161.725	Public Correspondence (Marine Operator), Port operation, ship movement
82A	X	X		S	157.125		U.S. Government Only, Canadian Coast Guard Only
83		X		D	157.175	161.775	Canadian Coast Guard Only
83A	X	X		S	157.175		U.S. Government Only, Canadian Coast Guard Only
83			X	D	157.175	161.775	Public Correspondence (Marine Operator)
84	X	X	X	D	157.225	161.825	Public correspondence (Marine Operator)
85	X	X	X	D	157.275	161.875	Public correspondence (Marine Operator)

VHF MARINE CHANNEL CHART							
CH	U	C	I	S/D	TX	RX	CHANNEL USE
86	X	X	X	D	157.325	161.925	Public correspondence (Marine Operator)
87	X	X	X	D	157.375	161.975	Public correspondence (Marine Operator)
88	X	X	X	D	157.425	162.025	Public correspondence (ship-to-coast)
88A	X			S	157.425		Commercial, Inter-ship Only
WX01	X	X	X	D	---	162.550	Weather (receive only)
WX02	X	X	X	D	---	162.400	Weather (receive only)
WX03	X	X	X	D	---	162.475	Weather (receive only)
WX04	X	X	X	D	---	162.425	Weather (receive only)
WX05	X	X	X	D	---	162.450	Weather (receive only)
WX06	X	X	X	D	---	162.500	Weather (receive only)
WX07	X	X	X	D	---	162.525	Weather (receive only)
WX08	X	X	X	D	---	161.650	Weather (receive only)
WX09	X	X	X	D	---	161.775	Weather (receive only)
WX10	X	X	X	D	---	163.275	Weather (receive only)

The **BOLD** channels above are not for use by the general public in US water, unless proper authorization is given.

Marine Products Limited Warranty

STANDARD HORIZON (a division of VERTEX STANDARD) warrants, to the original purchaser only, each new Marine Communications Product ("Product") manufactured and/or supplied by STANDARD HORIZON against defects in materials and workmanship under normal use and service for a period of time from the date of purchase as follows:

Fixed Mount and Portable Transceivers

1 year - if purchased before 01/01/91

3 years - if purchased between 01/01/91 and 01/01/94

3 years Waterproof - if purchased after 01/01/94

Loud hailers

1 year - if purchased before 01/01/91

3 years - if purchased after 01/01/91

Associated Chargers

1 year - if purchased before 01/01/91

3 years - if purchased after 01/01/91

Associated Batteries - 18 months. Note: Batteries will be deemed defective only if storage capacity drops below 80% of rated capacity or if leakage develops.

Associated Accessories- 1 year. Includes: Microphones/Handsets, External Speakers, Antennas, Carrying Accessories, Power Supplies, and Signaling Boards. To receive warranty service, the purchaser must deliver the Product, transportation and insurance prepaid, to STANDARD HORIZON (a division of VERTEX STANDARD), 115 North Wright Brothers Dr, Salt Lake City, Utah 84116-2838, phone number 800-366-4566. Include proof of purchase indicating model, serial number, and date of purchase. STANDARD HORIZON will return the Product to the purchaser freight prepaid. Products purchased prior to January 1, 1991 will bear the STANDARD HORIZON warranty terms in effect prior to that date.

In the event of a defect, malfunction or failure of the Product during the warranty period, STANDARD HORIZON's liability for any breach of contract or any breach of express or implied warranties in connection with the sale of Products shall be limited solely to repair or replacement, at its option, of the Product or part(s) therein which, upon examination by STANDARD HORIZON, appear to be defective or not up to factory specifications. STANDARD HORIZON may, at its option, repair or replace parts or subassemblies with new or reconditioned parts and subassemblies. Parts thus repaired or replaced are warranted for the balance of the original applicable warranty.

STANDARD HORIZON will not warrant installation, maintenance or service of the Products. In all instances, STANDARD HORIZON's liability for damages shall not exceed the purchase price of the defective Product. This warranty only extends to Products sold within the 50 States of the United States of America and the District of Columbia.

STANDARD HORIZON will pay all labor to repair the product and replacement parts charges incurred in providing the warranty service except where purchaser abuse or other qualifying exceptions exist. The purchaser must pay any transportation expenses incurred in returning the Product to STANDARD HORIZON for service.

This limited warranty does not extend to any Product which has been subjected to misuse, neglect, accident, incorrect wiring by anyone other than STANDARD HORIZON, improper installation, or subjected to use in violation of instructions furnished by STANDARD HORIZON, nor does this warranty extend to Products on which the serial number has been removed, defaced, or changed. STANDARD HORIZON cannot be responsible in any way for ancillary equipment not furnished by STANDARD HORIZON which is attached to or used in connection with STANDARD HORIZON's Products, or for the operation of the Product with any ancillary equipment, and all such equipment is expressly excluded from this warranty. STANDARD HORIZON disclaims liability for range, coverage, or operation of the Product and ancillary equipment as a whole under this warranty. STANDARD HORIZON reserves the right to make changes or improvements in Products, during subsequent production, without incurring the obligation to install such changes or improvements on previously manufactured Products.

The implied warranties which the law imposes on the sale of this Product are expressly LIMITED, in duration, to the time period specified above. STANDARD HORIZON shall not be liable under any circumstances for consequential damages resulting from the use and operation of this Product, or from the breach of this LIMITED WARRANTY, any implied warranties, or any contract with STANDARD HORIZON. IN CONNECTION WITH THE SALE OF ITS PRODUCTS, STANDARD HORIZON MAKES NO WARRANTIES, EXPRESS OR IMPLIED AS TO THE MERCHANTABILITY OR FITNESS FOR A PARTICULAR PURPOSE OR OTHERWISE, EXCEPT AS EXPRESSLY SET FORTH HEREIN.

Some states do not allow the exclusion or limitation of incidental or consequential damages, or limitation on how long an implied warranty lasts, so the above limitations or exclusions may not apply. This warranty gives specific legal rights, and there may be other rights which may vary from state to state.

ONLY PRODUCTS SOLD ON OR AFTER JANUARY 1, 1991 ARE COVERED UNDER THE TERMS OF THIS LIMITED WARRANTY.

ON-LINE WARRANTY REGISTRATION

THANK YOU for buying STANDARD HORIZON (a division of Vertex Standard) products! We are confident your new radio will serve your needs for many years!

Please visit www.standardhorizon.com to register the SPECTRUM+ Marine VHF. It should be noted that visiting the Web site from time to time may be beneficial to you, as new products are released they will appear on the STANDARD HORIZON Web site. Also a statement regarding product support should be added to the manual.

Product Support Inquiries

If you have any questions or comments regarding the use of the SPECTRUM+, you can visit the STANDARD HORIZON Web site to send an E-Mail or contact the Product Support team at 562/404-2700 M-F 7:00-5:00PST.

In addition to the warranty, STANDARD HORIZON includes a lifetime "flat rate" program to provide service after the warranty period has expired. If you wish to obtain the flat rate price for out-of-warranty repair, you must include the information on the Owner's Record with the unit when you return it to your Dealer or to STANDARD HORIZON.

Lifetime Flat Rate Service Program: For the original Owner only, for the lifetime of the unit, STANDARD HORIZON will repair the unit to original specifications.

Note: The flat rate amount is payable by the Owner only if STANDARD HORIZON or the STANDARD HORIZON Dealer determines that a repair is needed. After the repair, a 90-day warranty will be in effect from the date of return of the unit to the Owner.

This service program is not available for equipment which has failed as a result of neglect, accident, breakage, misuse, improper installation or modification, or water damage. (depending on the product)

Model		Serial Number	
Purchase Date	Dealer		

Performance specifications are nominal, unless otherwise indicated, and are subject to change without notice.

13.1 GENERAL

Channels	All USA, International and Canadian
Input Voltage	13.8 VDC \pm 20%
Current Drain	
Standby	0.5A
Receive	1.5A
Transmit	6A (Hi); 1.7A (Lo)
Dimensions	3-1/8" H x 6-7/8" W x 7-1/4" D (80 H x 176 W x 185 D mm)
Flush-Mount Dimensions	2" H x 5-5/8" W x 5-1/4" D (51 H x 143 W x 133 D mm)
Weight	2.73 Lb. (1.24 kg)

13.2 TRANSMITTER

Frequency Range	156.025 to 157.425 MHz
RF Output	25 W (Hi); 1 W (Lo)
Conducted Spurious Emissions	80 dB (Hi); 60 dB (Lo)
Audio Response	within $\pm 1/-3$ of a 6 dB/octave pre-emphasis characteristic at 300 to 3000 Hz
Audio Distortion	5 %
Modulation	16K0G3E, for DSC 16K0G2B
Frequency Stability (-20° to +50°C)	\pm 0.0005%
FM Hum and Noise	50 dB

13.3 RECEIVER

Frequency Range	156.050 to 163.275 MHz
Sensitivity:	
20 dB Quieting	0.35 μ V
12 dB SINAD	0.25 μ V
Squelch Sensitivity (Threshold)	0.13 μ V
Modulation Acceptance Bandwidth	\pm 7.5 kHz

Selectivity:

Spurious and Image Rejection	- 75 dB
Intermodulation and Rejection at 12 dB SINAD	- 75 dB
Audio Output	4 W
Audio Response	within + 2/-8 of a 6 dB/octave de-emphasis characteristic at 300 to 3000 Hz
Frequency Stability (-20° to +50°C)	± 0.0005 %
Channel Spacing	25 kHz

13.4 DSC

DSC Format	RTCMSC101
NMEA 0183 Input	GLL, RMC
NMEA 0183 Output	DSC, DSE



Marine Division of Vertex Standard
US Headquarters
17210 Edwards Rd., Cerritos, CA 90703

Phone 562/404-2700
Fax 800/552/6813
Email marinetech@vxstd.com
www.vxstd.com

Printed in China
03/2002
03AX851010

